

# 2025 MULE™ 4010 4x4

## PARTS DIAGRAM

### Frame Fittings

F2131

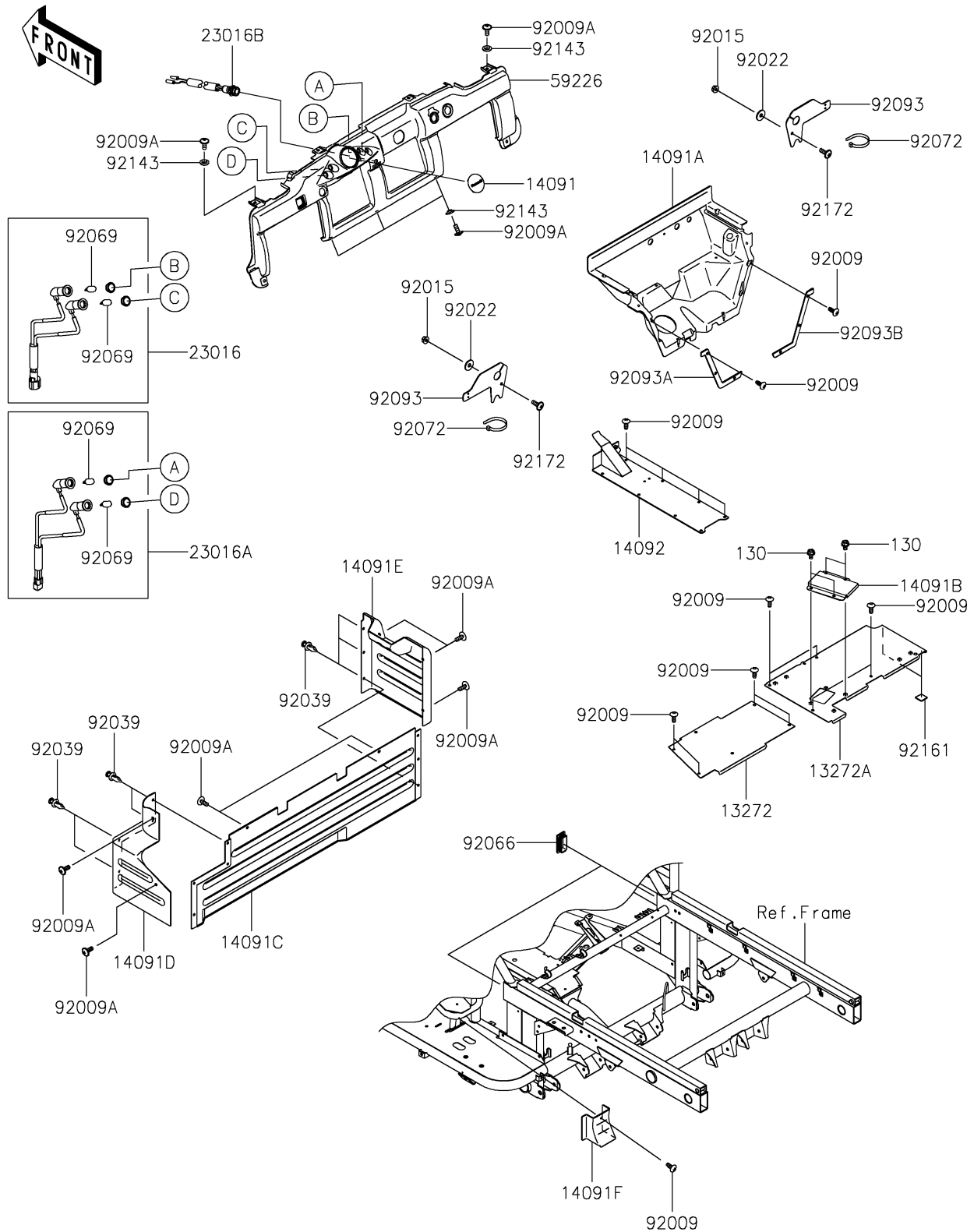

# 2025 MULE™ 4010 4x4

## PARTS LIST

### Frame Fittings



ITEM NAME	PART NUMBER	QUANTITY
-----------	-------------	----------

---