

2025 MULE™ 4010 TRANS4x4® FE

PARTS DIAGRAM

Water Pump

E3031

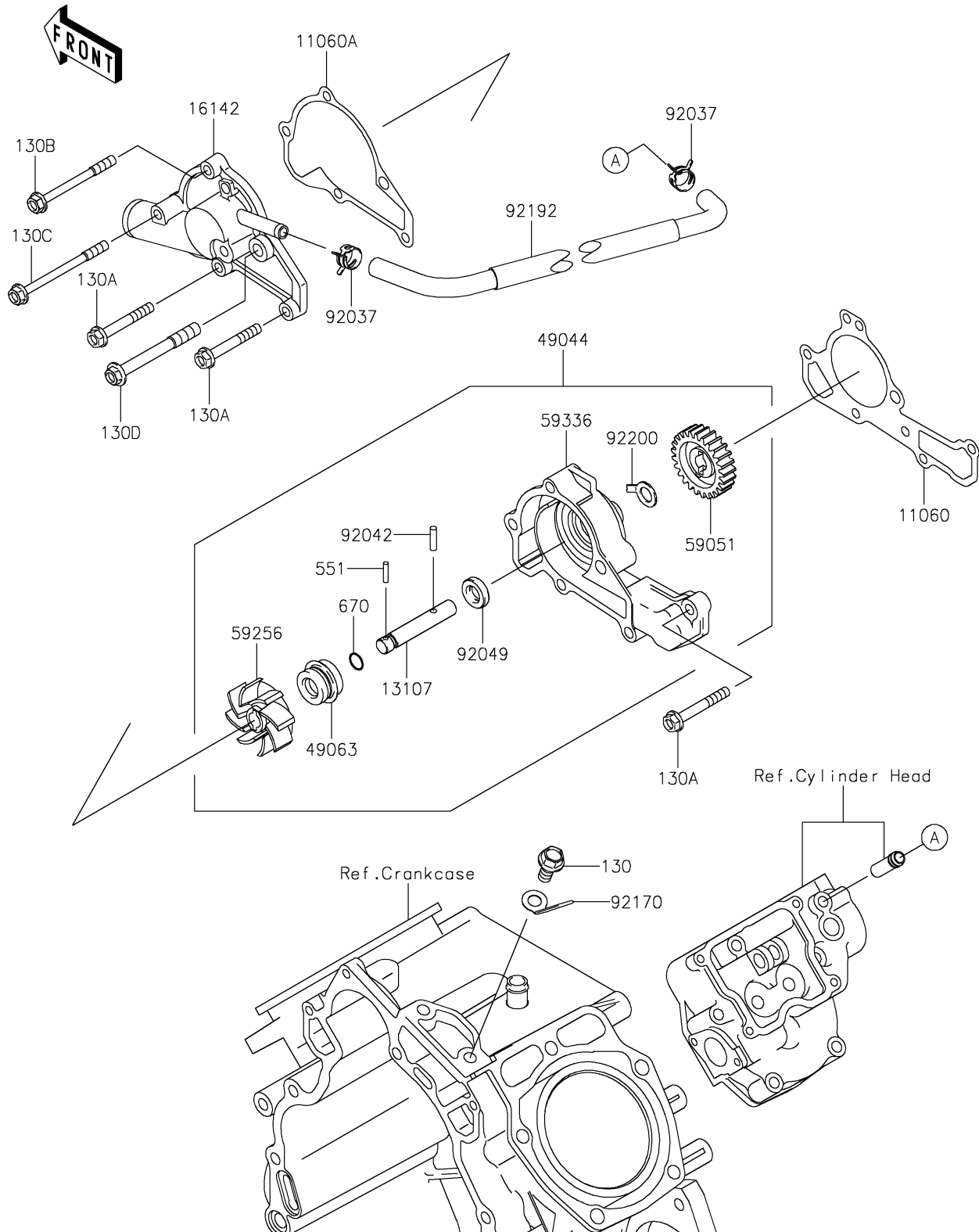

2025 MULE™ 4010 TRANS4x4® FE



PARTS LIST

Water Pump

ITEM NAME	PART NUMBER	QUANTITY
-----------	-------------	----------
