

# 2025 NINJA® 650

## PARTS DIAGRAM

### Frame Fittings

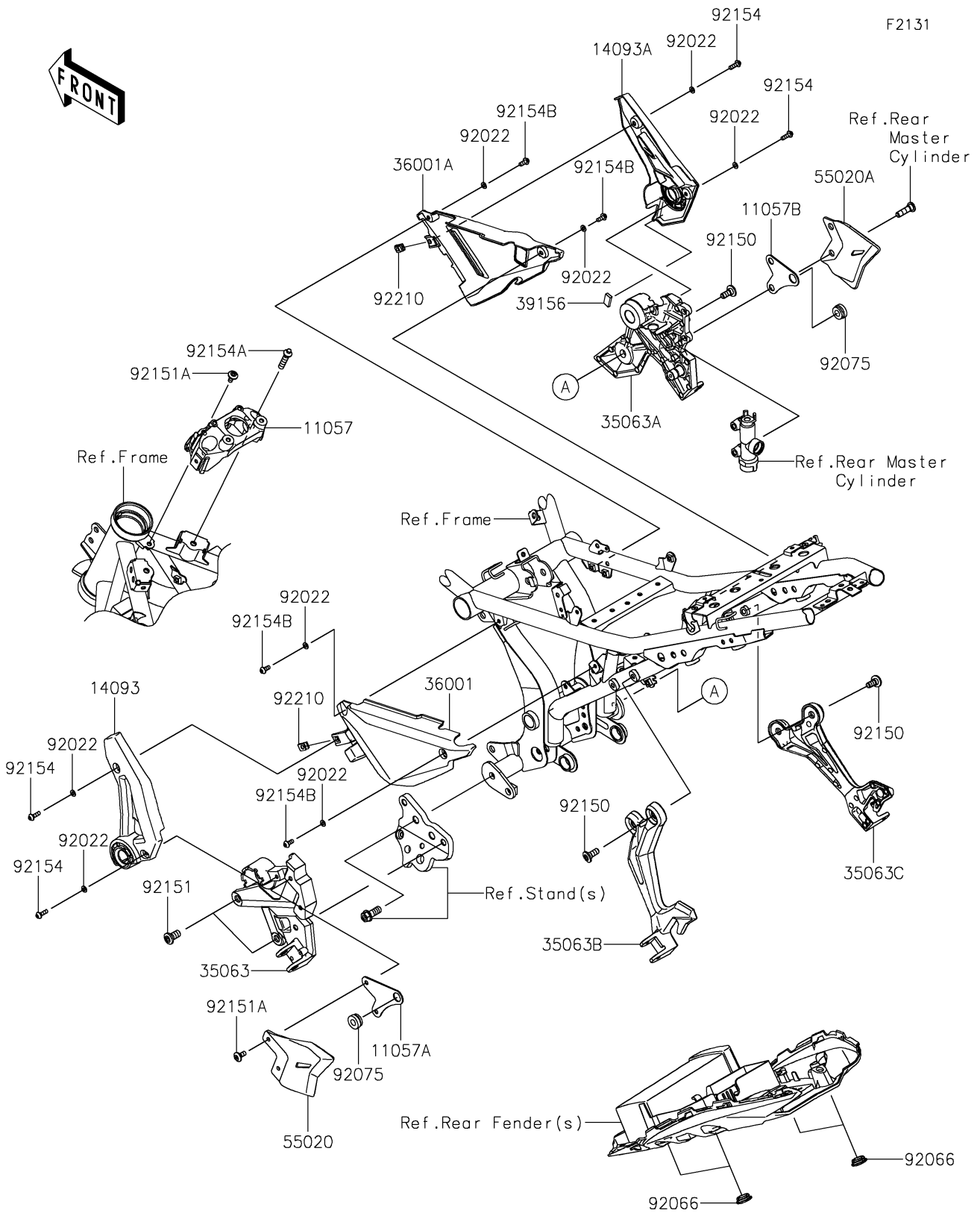

# 2025 NINJA® 650

## PARTS LIST Frame Fittings



**ITEM NAME**

**PART NUMBER**

**QUANTITY**

---