

# 2024 NINJA® ZX™-10RR ABS

## PARTS DIAGRAM

Stand(s)

F2190

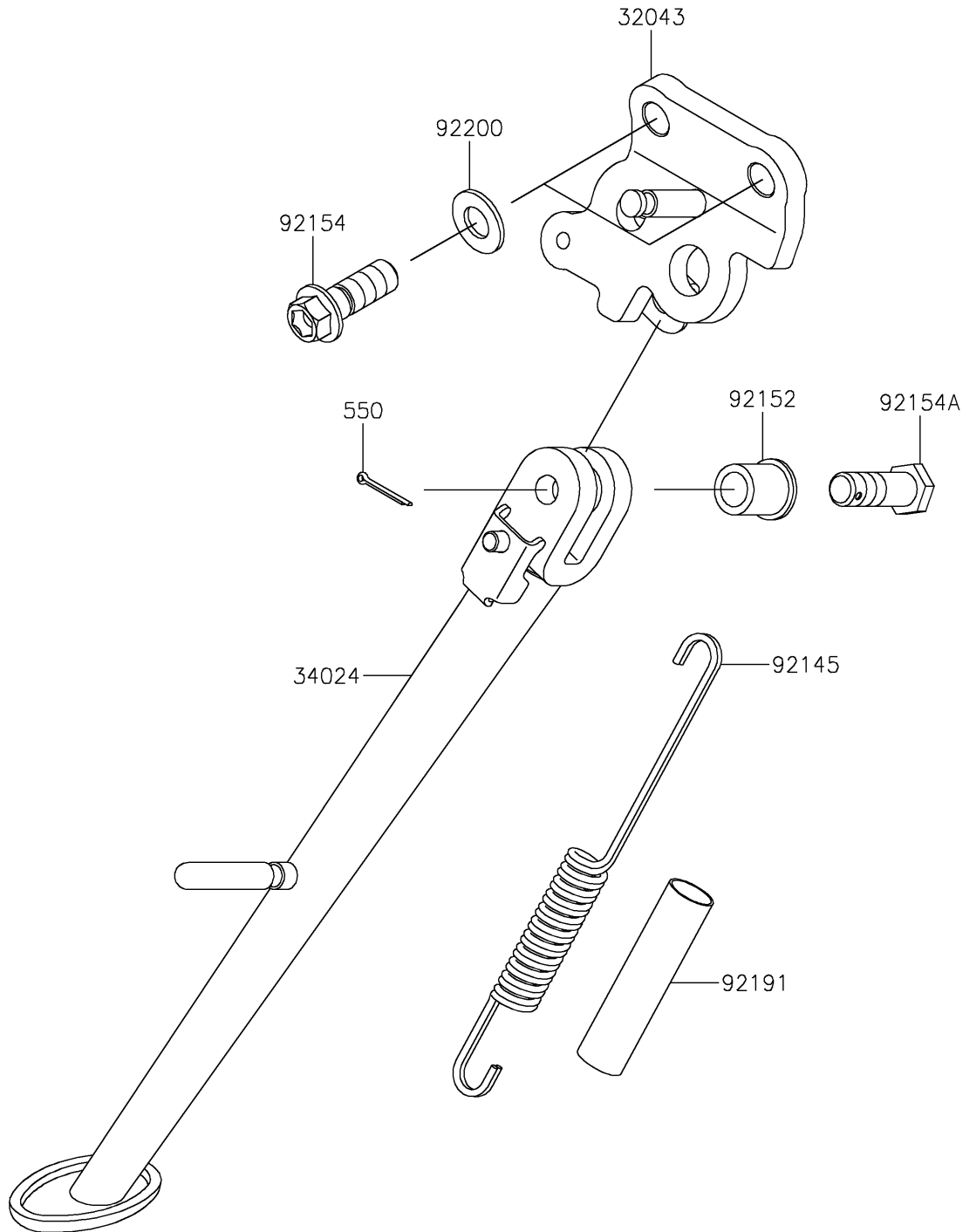

# 2024 NINJA® ZX™-10RR ABS

## PARTS LIST

Stand(s)

**ITEM NAME**

**PART NUMBER**

**QUANTITY**

---