

# 2024 VULCAN® S

## PARTS DIAGRAM

### Taillight(s)

F2720

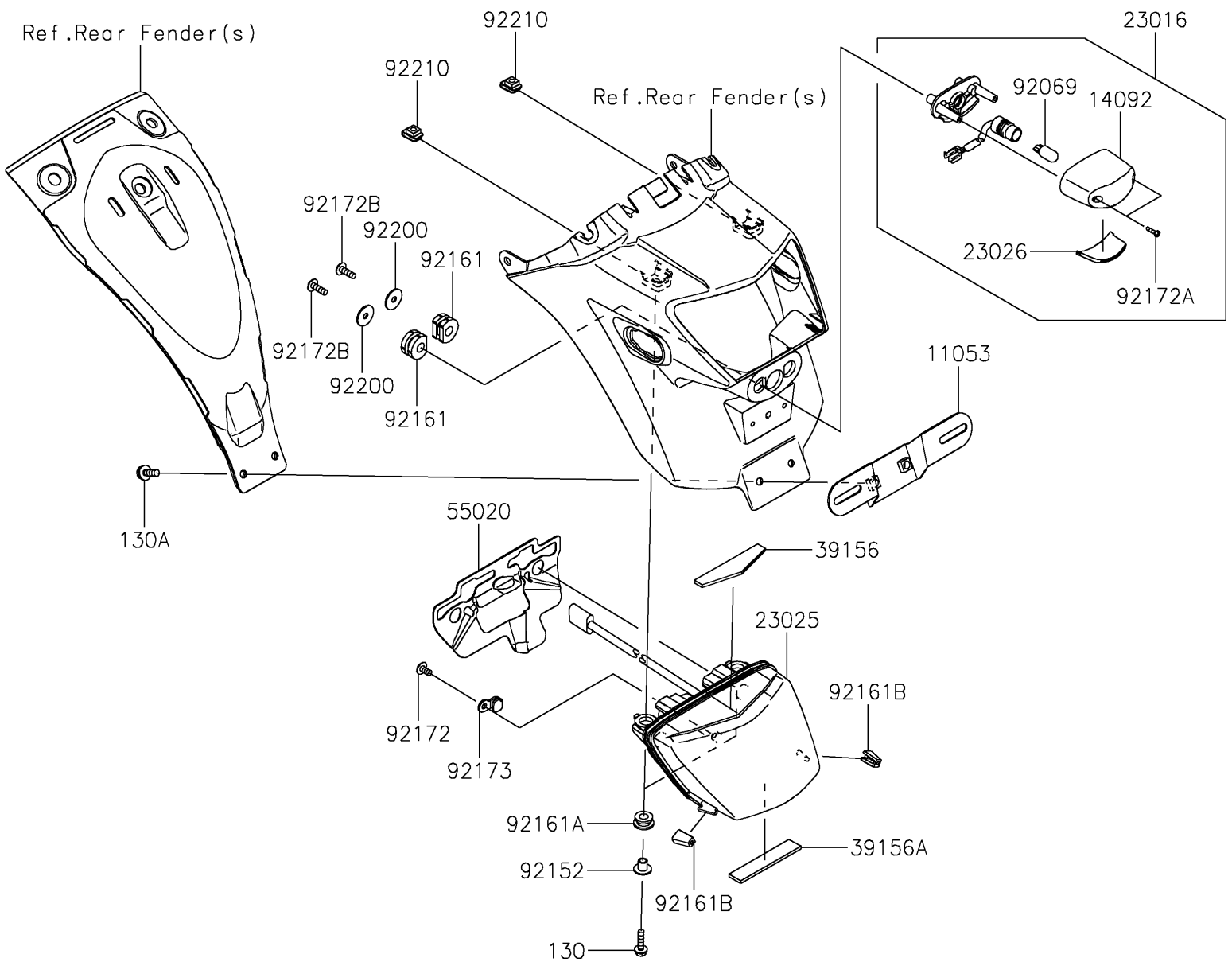

# 2024 VULCAN® S

## PARTS LIST

Taillight(s)

**ITEM NAME**

**PART NUMBER**

**QUANTITY**

---