

2024 VULCAN® S

PARTS DIAGRAM

Front Brake

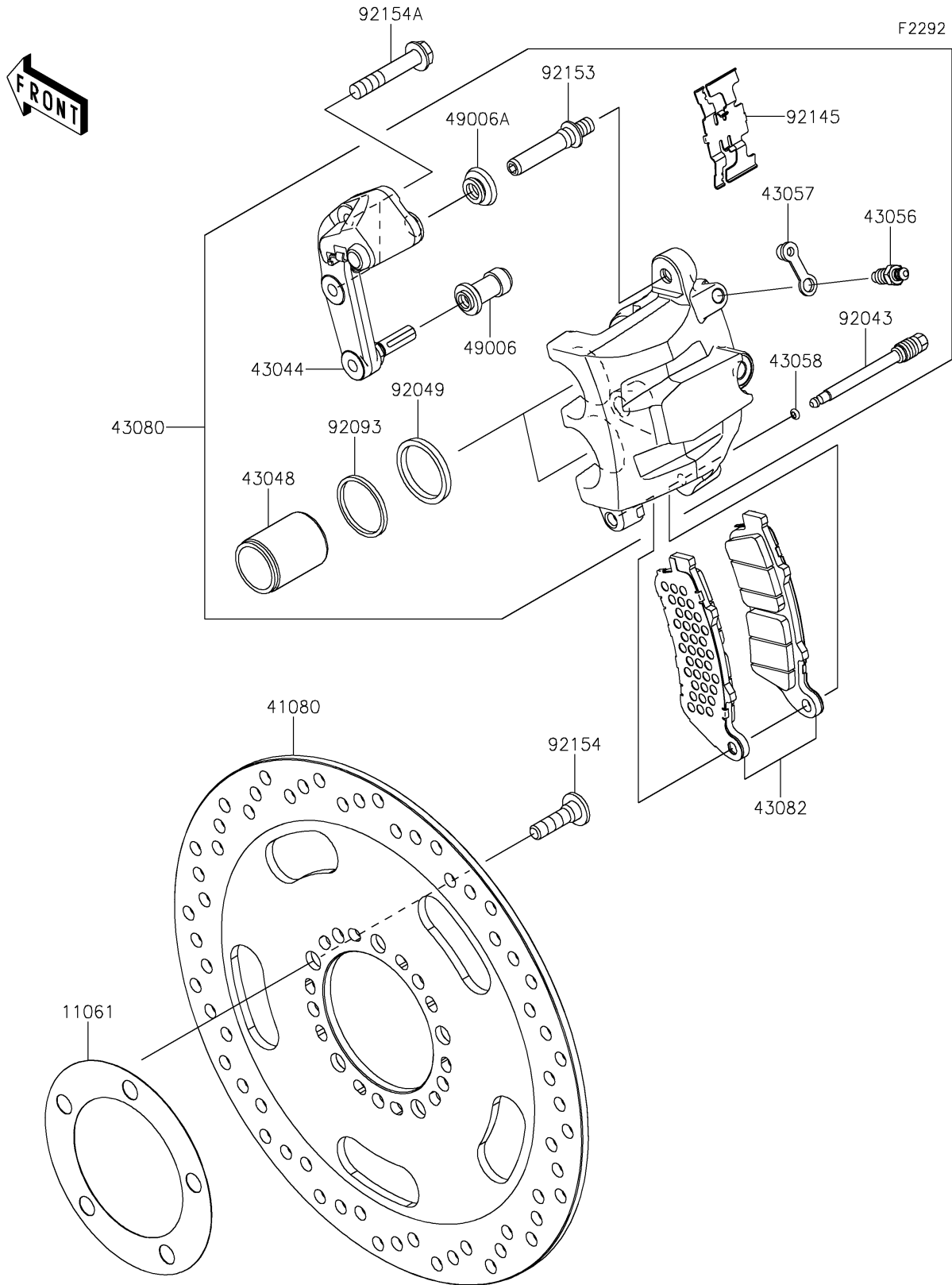

2024 VULCAN® S

PARTS LIST

Front Brake



ITEM NAME	PART NUMBER	QUANTITY
-----------	-------------	----------
