

# 2025 Vulcan S

## PARTS DIAGRAM

### Tires

F2210

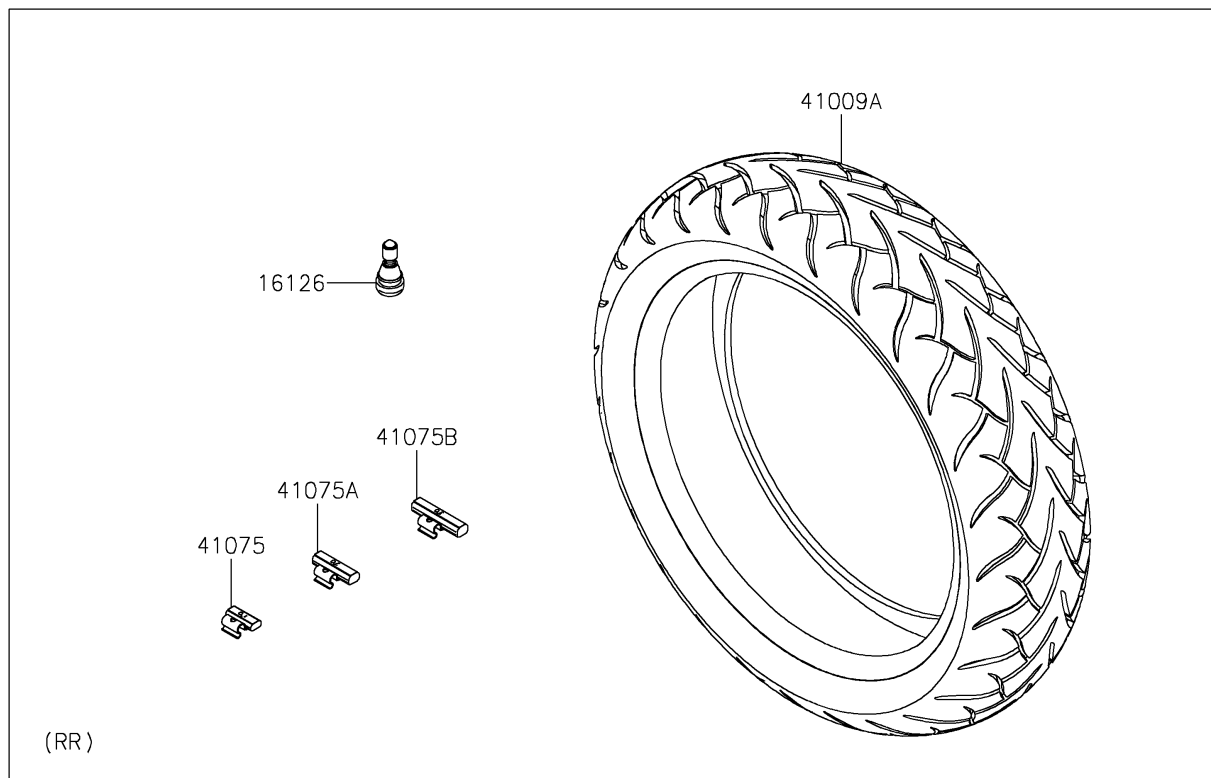
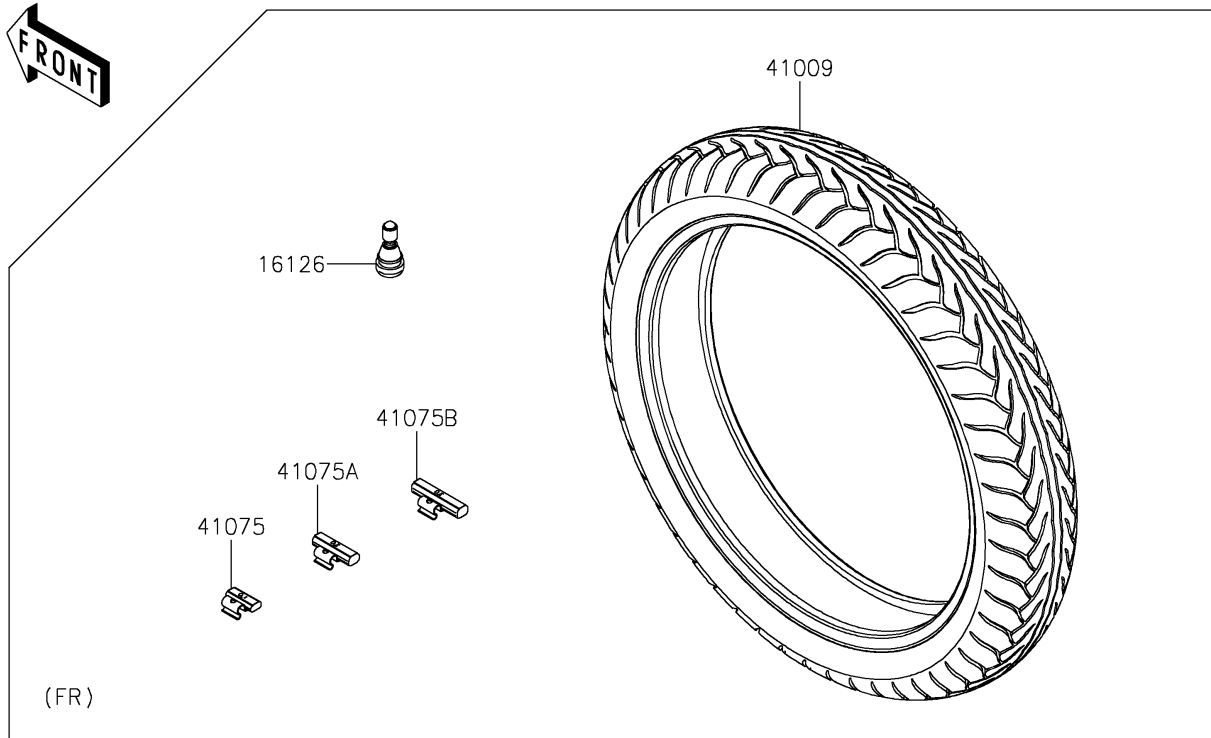

# 2025 Vulcan S

## PARTS LIST

### Tires

**ITEM NAME**

**PART NUMBER**

**QUANTITY**

---