

# 2024 VULCAN® S

## PARTS DIAGRAM

### Swingarm

F2141

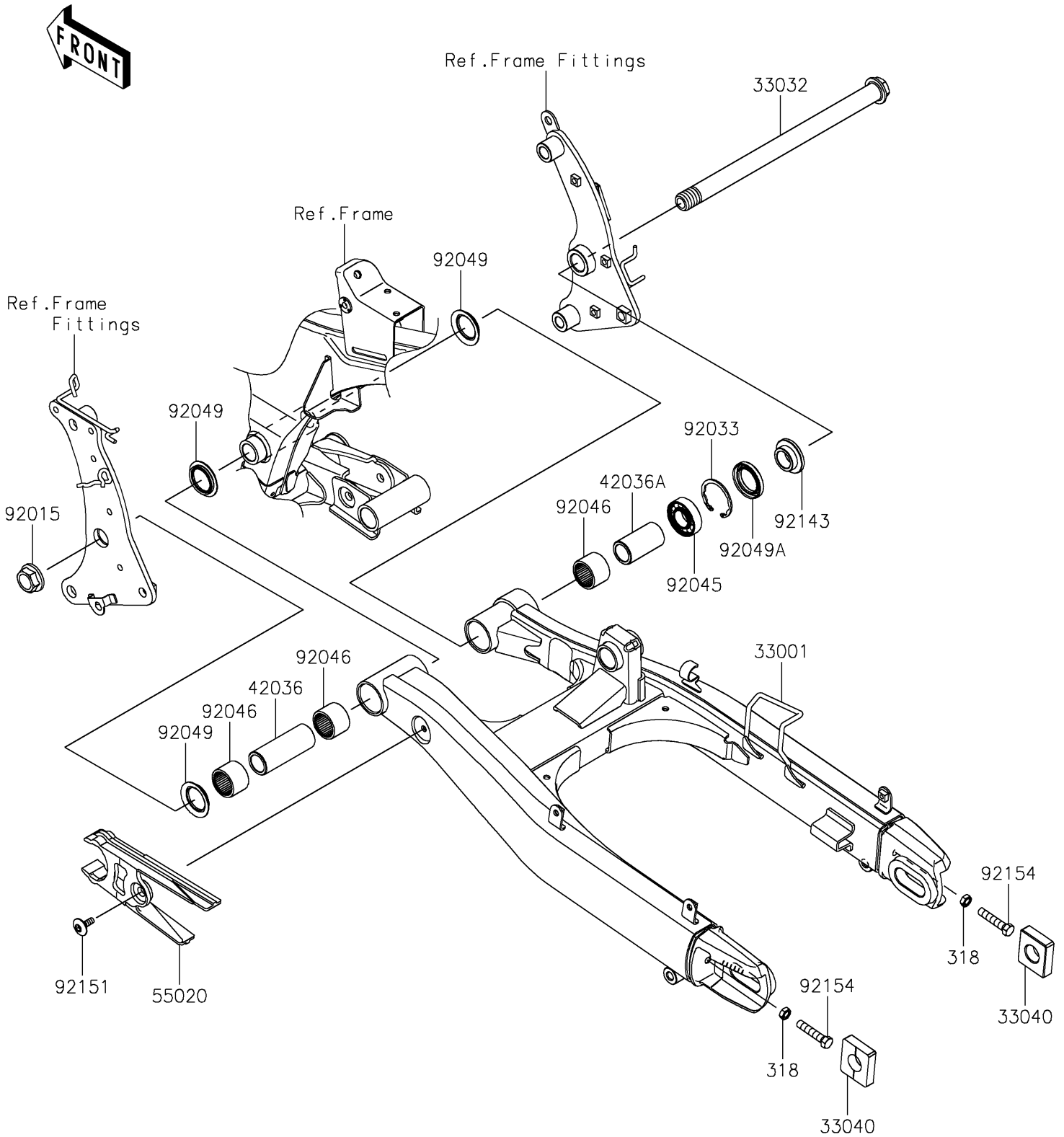

# 2024 VULCAN® S

## PARTS LIST

### Swingarm

**ITEM NAME**

**PART NUMBER**

**QUANTITY**

---