

# 2025 NINJA® ZX™-10R

## PARTS DIAGRAM

### Crankcase

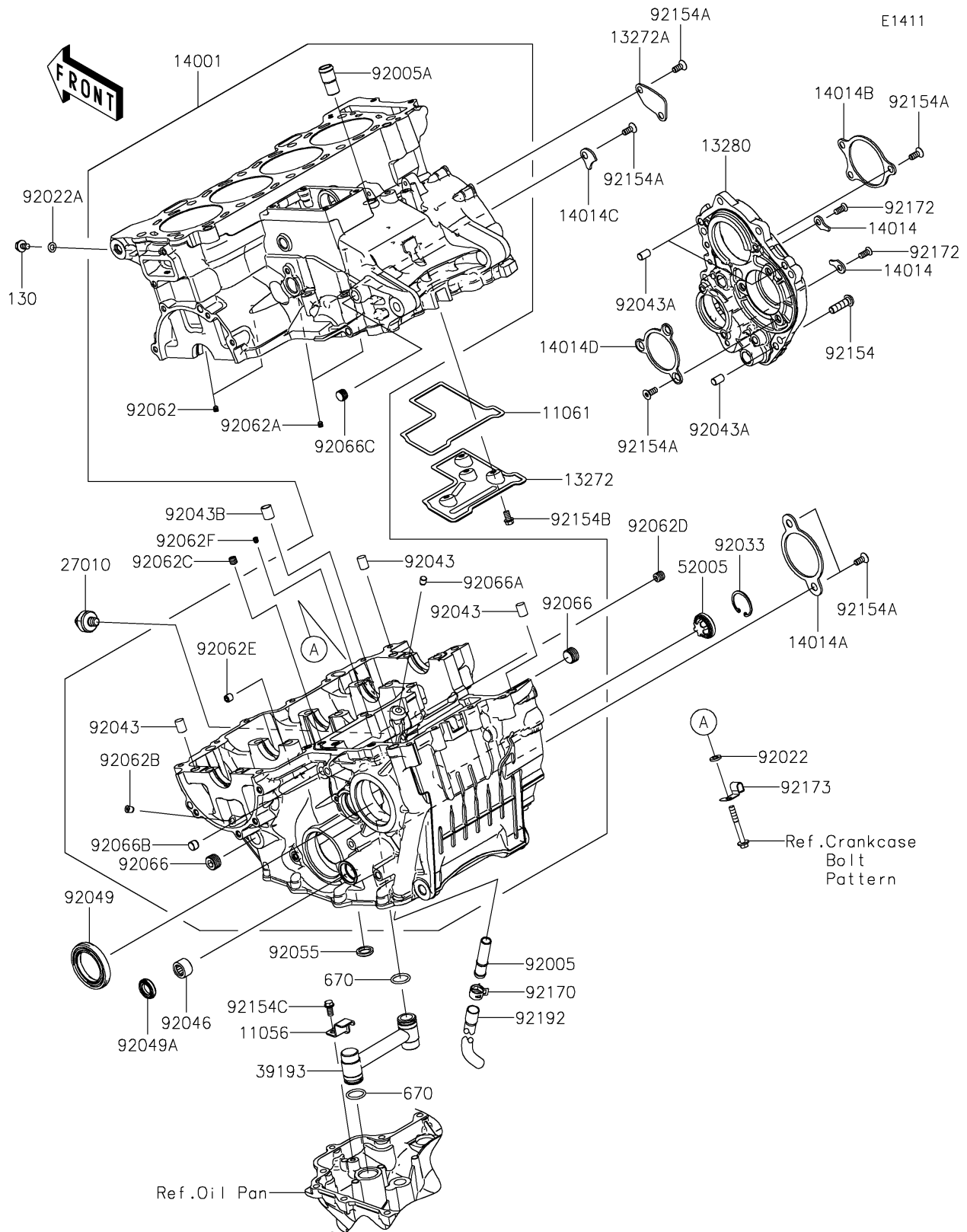

# 2025 NINJA<sup>®</sup> ZX<sup>™</sup>-10R

## PARTS LIST

### Crankcase

**ITEM NAME**

**PART NUMBER**

**QUANTITY**

---