

# 2023 VULCAN® 1700 VOYAGER® ABS

## PARTS DIAGRAM

### Owner's Tools

56007

F2810

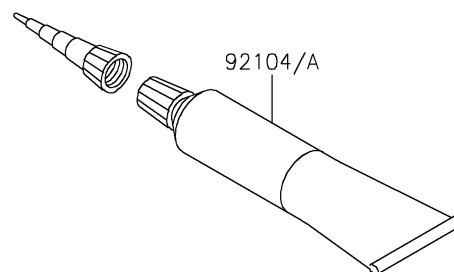
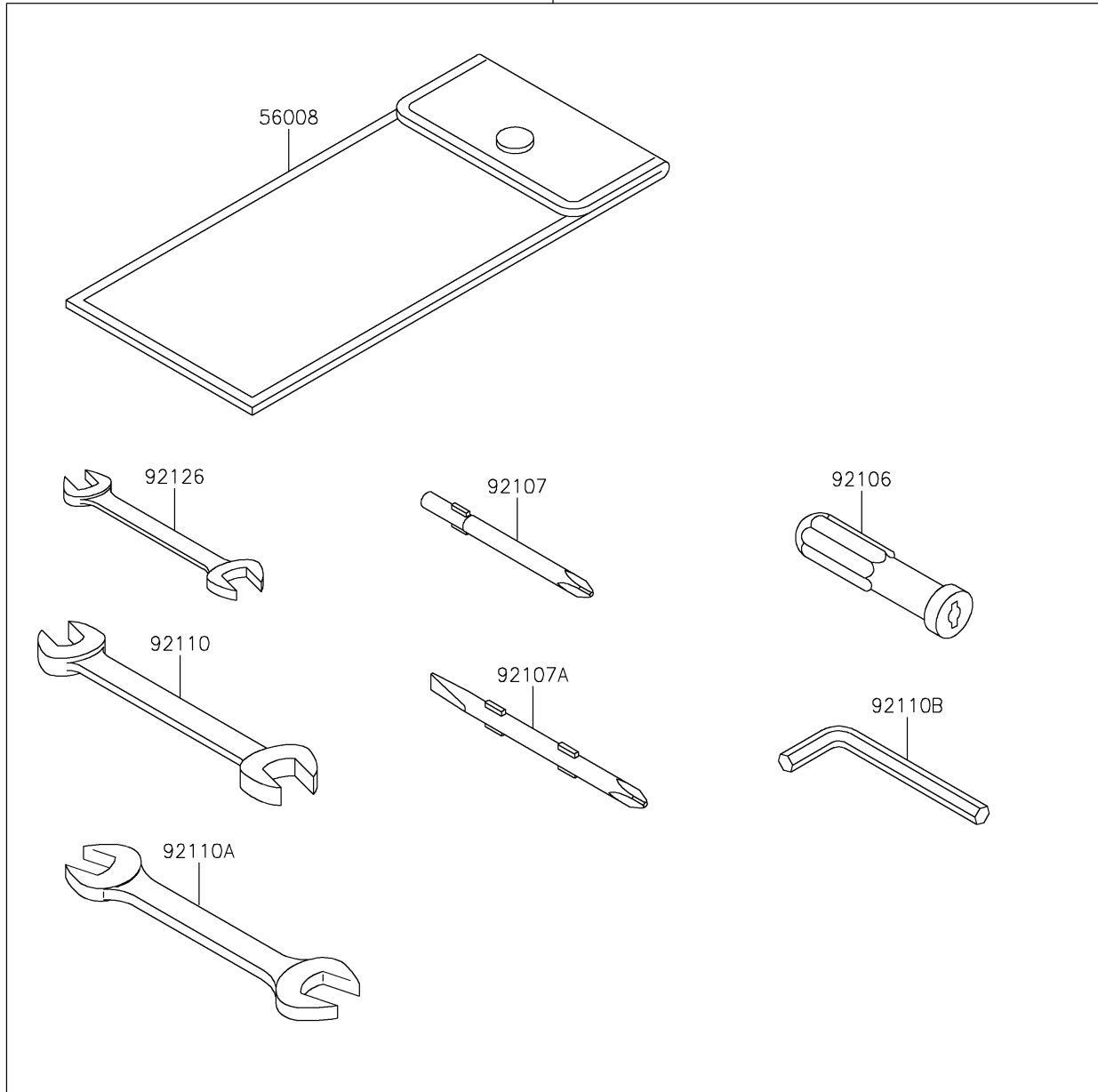

# 2023 VULCAN® 1700 VOYAGER® ABS



## PARTS LIST Owner's Tools

ITEM NAME	PART NUMBER	QUANTITY
-----------	-------------	----------

---