

# 2023 MULE™ 4010 TRANS4x4®

## PARTS DIAGRAM

### Side Covers/Chain Cover

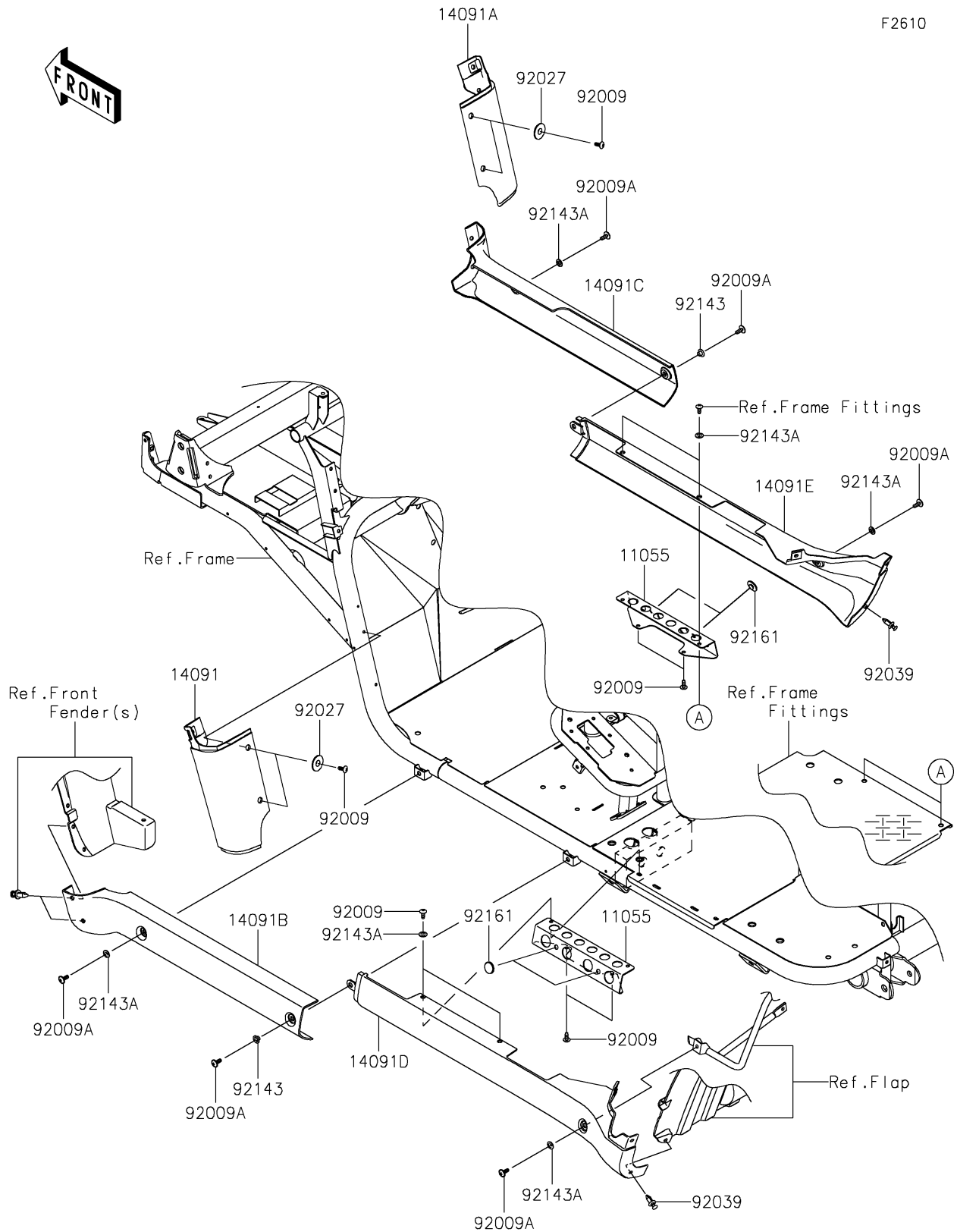

# 2023 MULE™ 4010 TRANS4x4®

## PARTS LIST

### Side Covers/Chain Cover

ITEM NAME	PART NUMBER	QUANTITY
-----------	-------------	----------

---