

2010 Z750 (European)

PARTS DIAGRAM

Battery Case

F2132

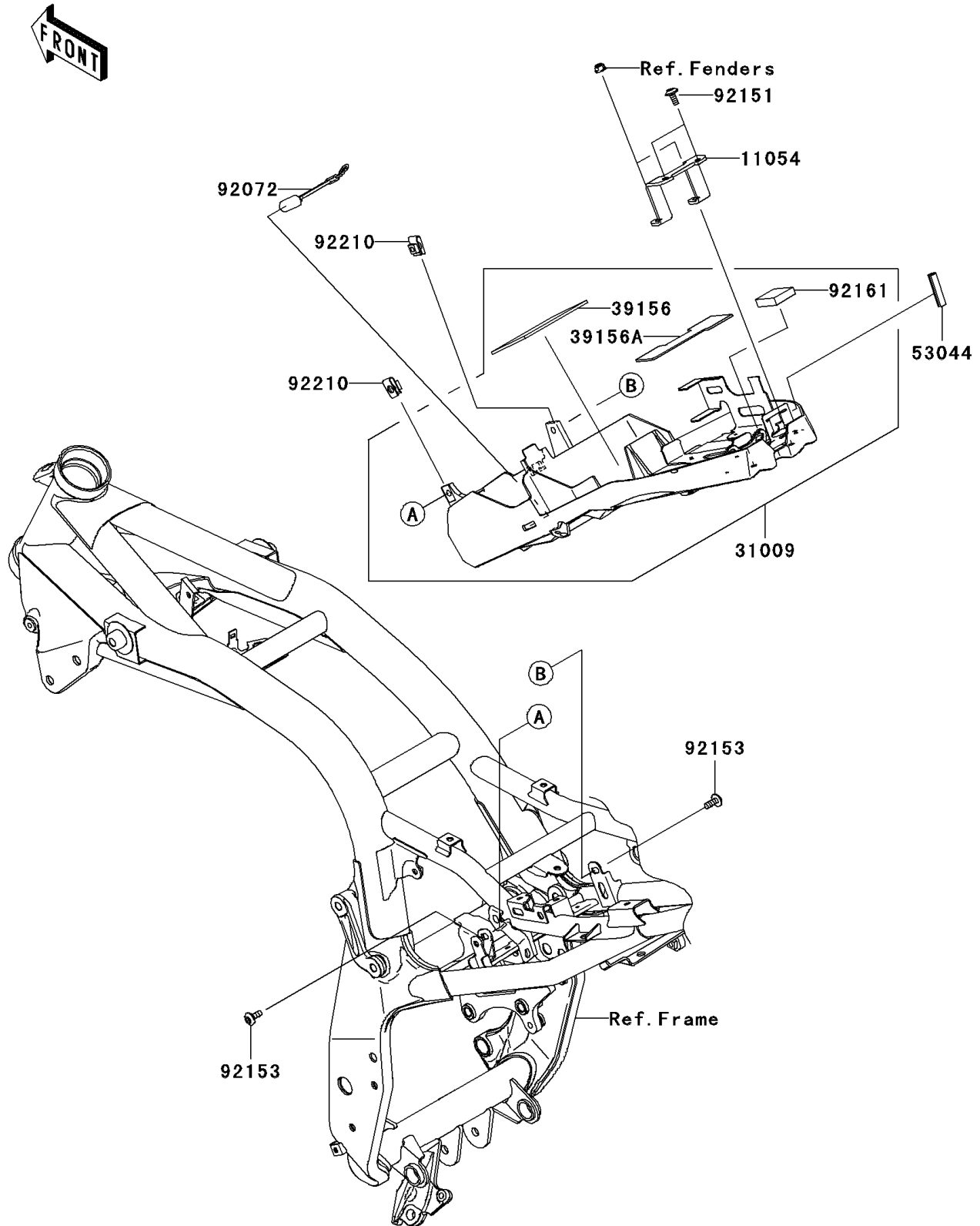

2010 Z750 (European)

PARTS LIST

Battery Case

ITEM NAME

PART NUMBER

QUANTITY
