

2002 ZR-7S

PARTS DIAGRAM

Ignition System

E1830

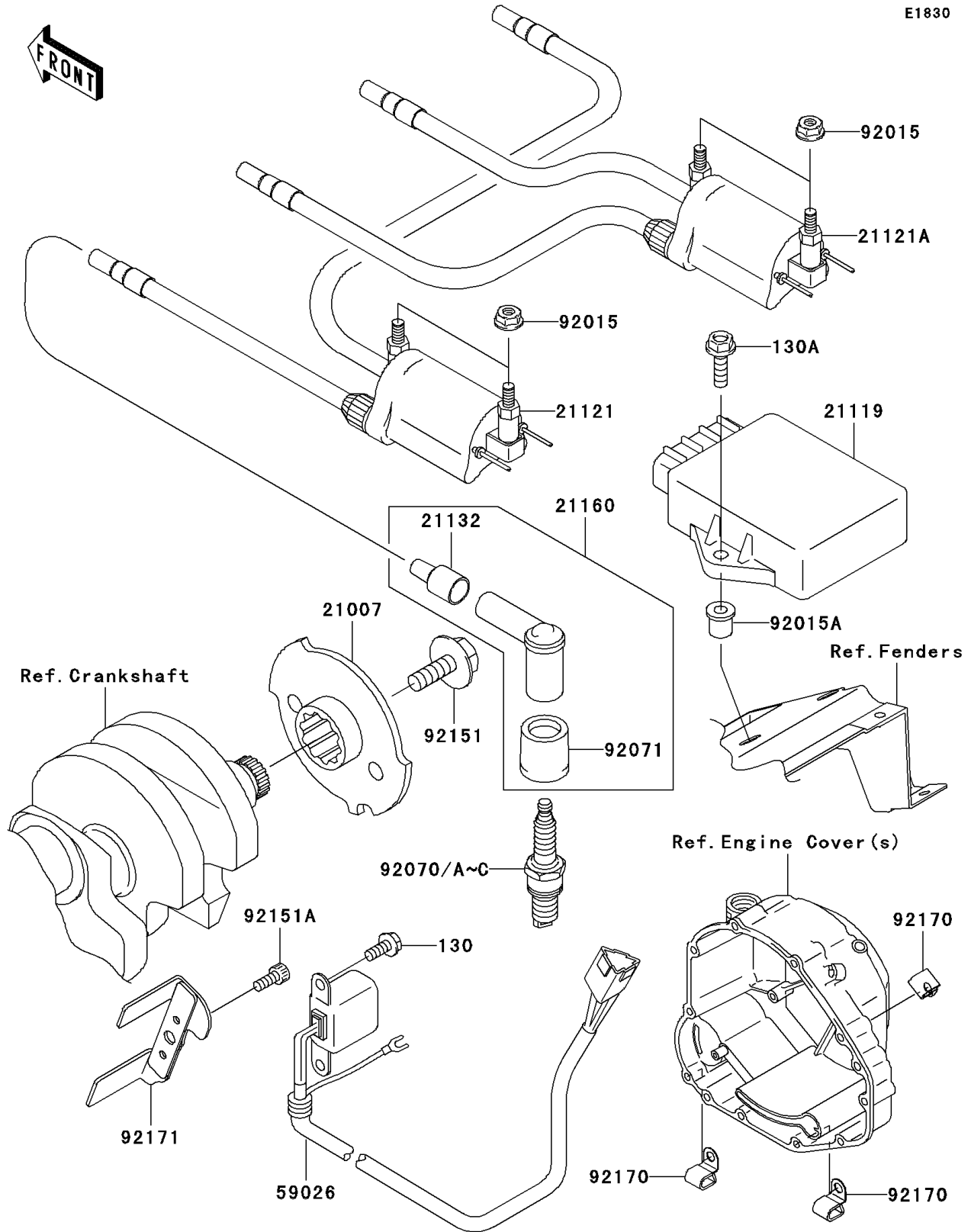

2002 ZR-7S

PARTS LIST

Ignition System

ITEM NAME	PART NUMBER	QUANTITY
BOLT-FLANGED (Ref # 130)	130G0512	2
BOLT-FLANGED (Ref # 130A)	130J0620	2
ROTOR (Ref # 21007)	21007-1353	1
IGNITER (Ref # 21119)	21119-1541	1
COIL-IGNITION,#1 (Ref # 21121)	21121-1177	1
COIL-IGNITION,#2 (Ref # 21121A)	21121-1178	1
GROMMET,HIGH TENSION (Ref # 21132)	21132-005	4
CAP-ASSY-PLUG (Ref # 21160)	21160-1085	4
COIL-PULSING (Ref # 59026)	59026-1152	1
NUT,FLANGED,6MM (Ref # 92015)	92015-1193	4
NUT (Ref # 92015A)	92015-1700	2
PLUG-SPARK,X24ESR-U(ND) (Ref # 92070)		AR
PLUG-SPARK,X27ESR-U(ND) (Ref # 92070A)		4
PLUG-SPARK,DR9EA(NGK) (Ref # 92070B)	92070-1189	4
PLUG-SPARK,DR8EA(NGK) (Ref # 92070C)	92070-1199	AR
GROMMET,PLUG CAP (Ref # 92071)	92071-1184	4
BOLT,8X23 (Ref # 92151)	92151-1308	1
BOLT,SOCKET,5X12 (Ref # 92151A)	92151-1365	1
CLAMP (Ref # 92170)	92170-1577	3
CLAMP (Ref # 92171)	92171-1150	1