

# 2020 MULE™ 4010 TRANS4x4®

## PARTS DIAGRAM

### Cables

F2540

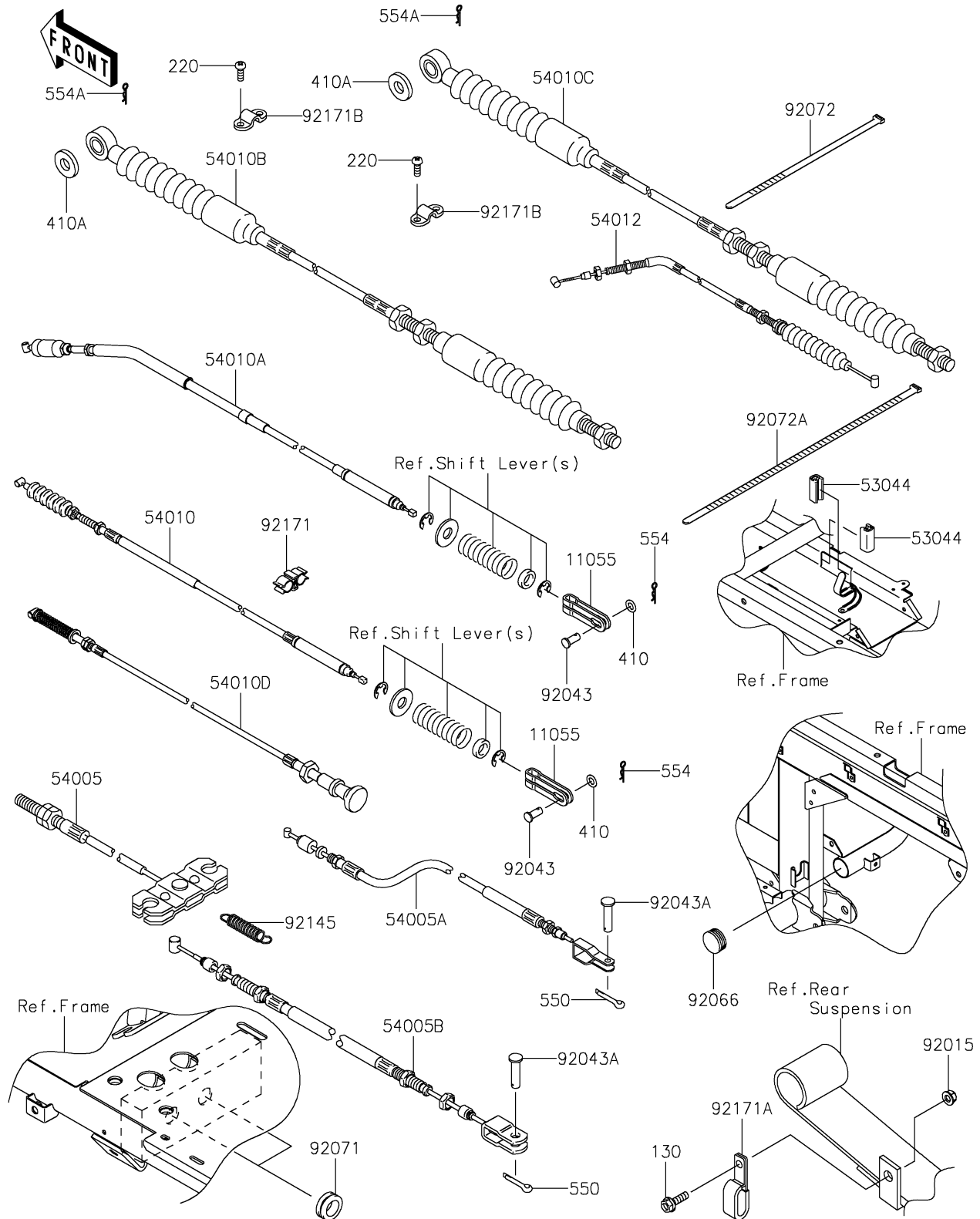

# 2020 MULE™ 4010 TRANS4x4®

## PARTS LIST

### Cables



**ITEM NAME**

**PART NUMBER**

**QUANTITY**

---