

# 2020 MULE™ 4010 TRANS4x4®

## PARTS DIAGRAM

### Seat

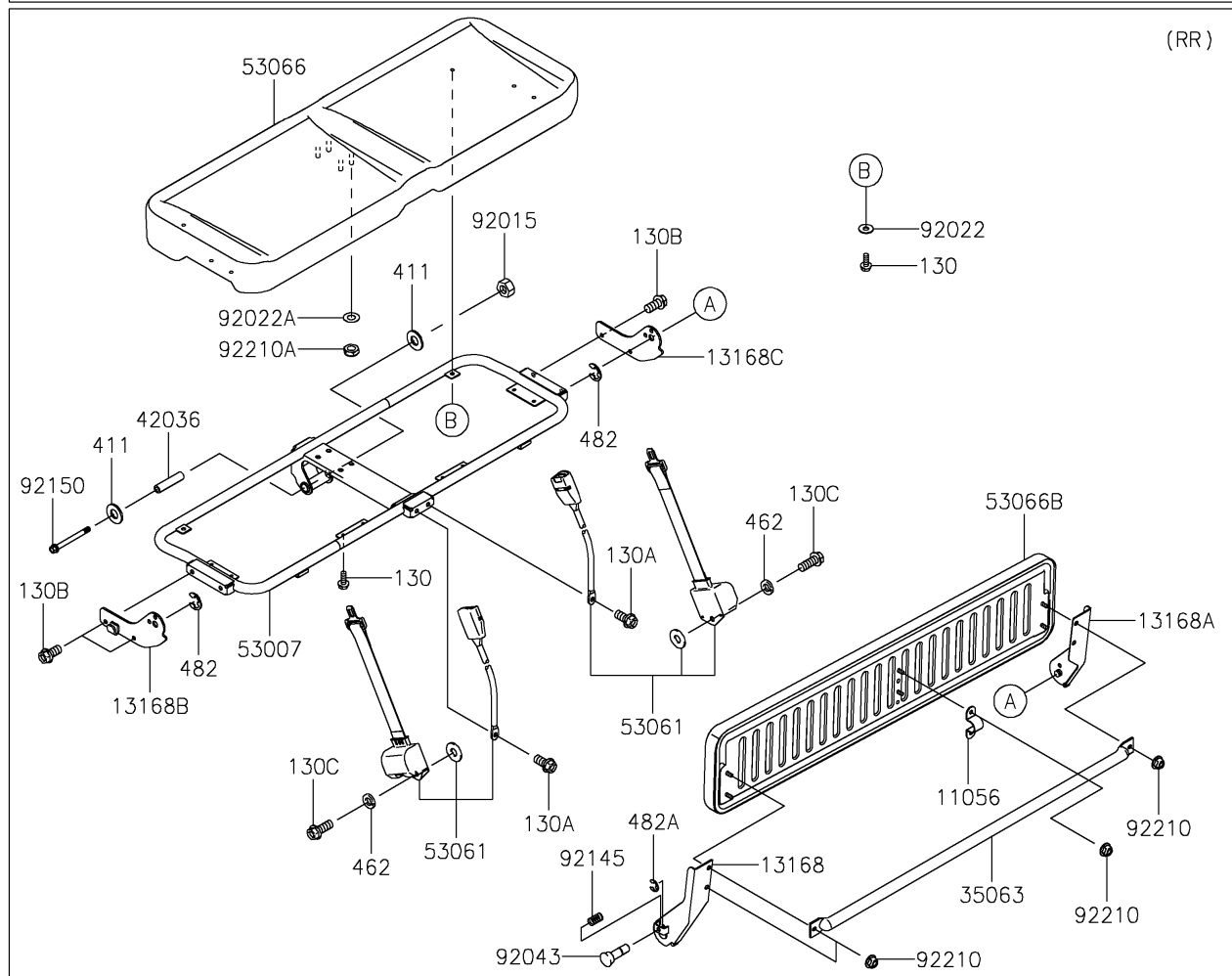
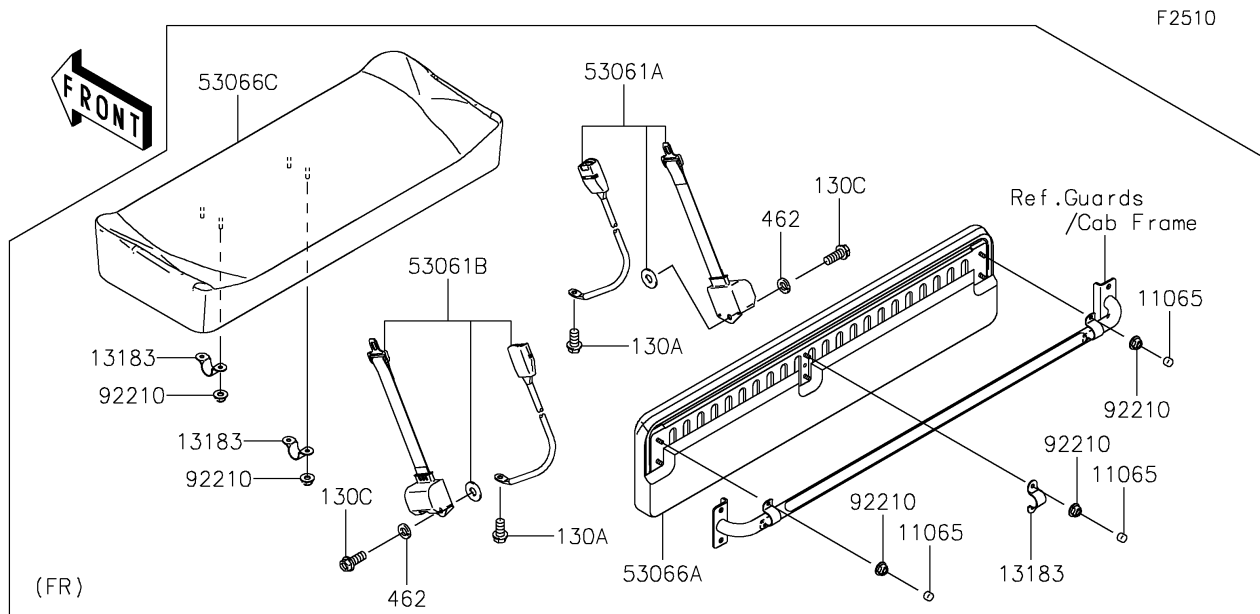

# 2020 MULE™ 4010 TRANS4x4®

## PARTS LIST

Seat

**ITEM NAME**

**PART NUMBER**

**QUANTITY**

---