

# 2018 MULE 4000 TRANS™

## PARTS DIAGRAM

### Decals

F2861

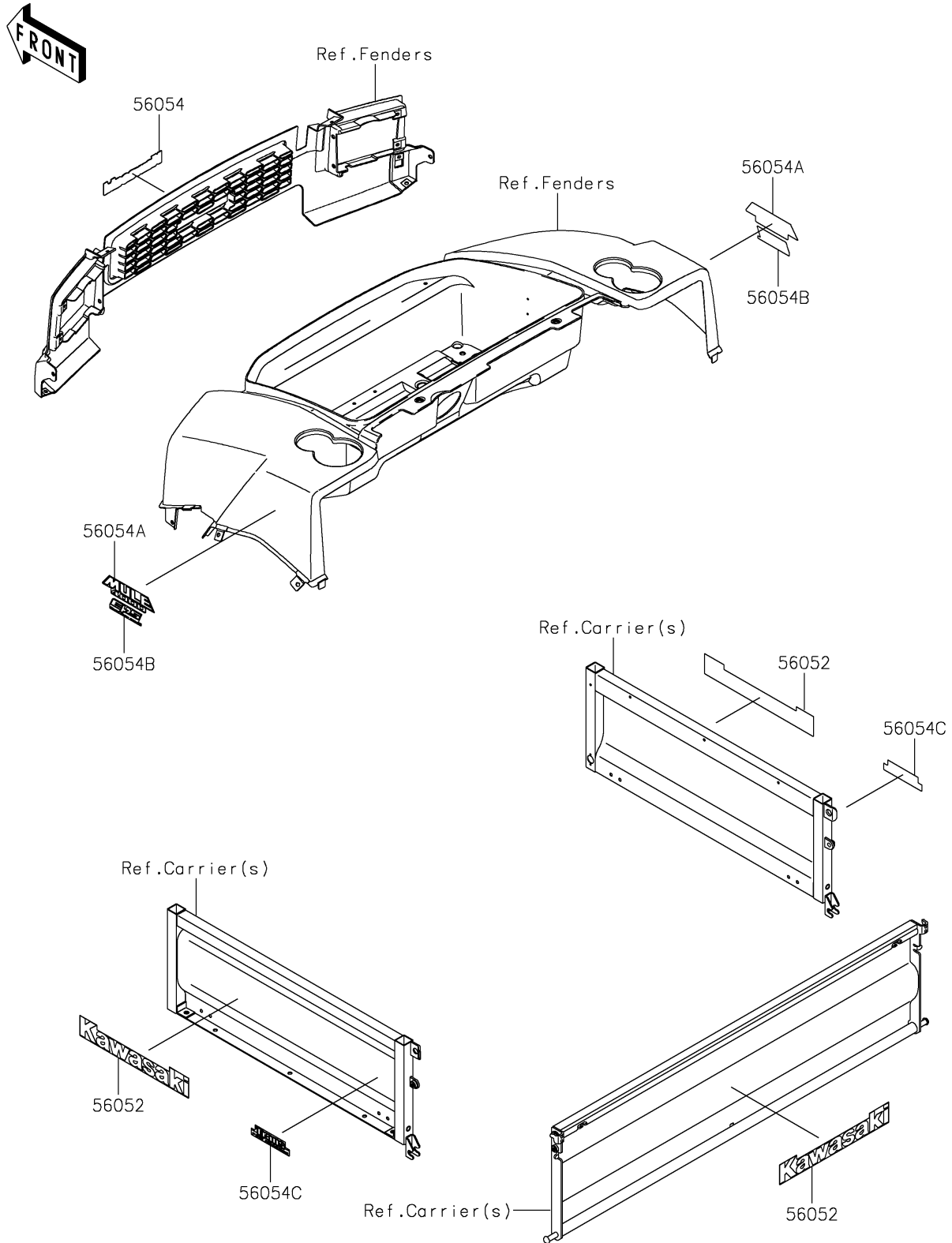

# 2018 MULE 4000 TRANS™

## PARTS LIST

### Decals

**ITEM NAME**

**PART NUMBER**

**QUANTITY**

---