

# 2018 MULE 4000 TRANS™

## PARTS DIAGRAM

### Ignition Switch

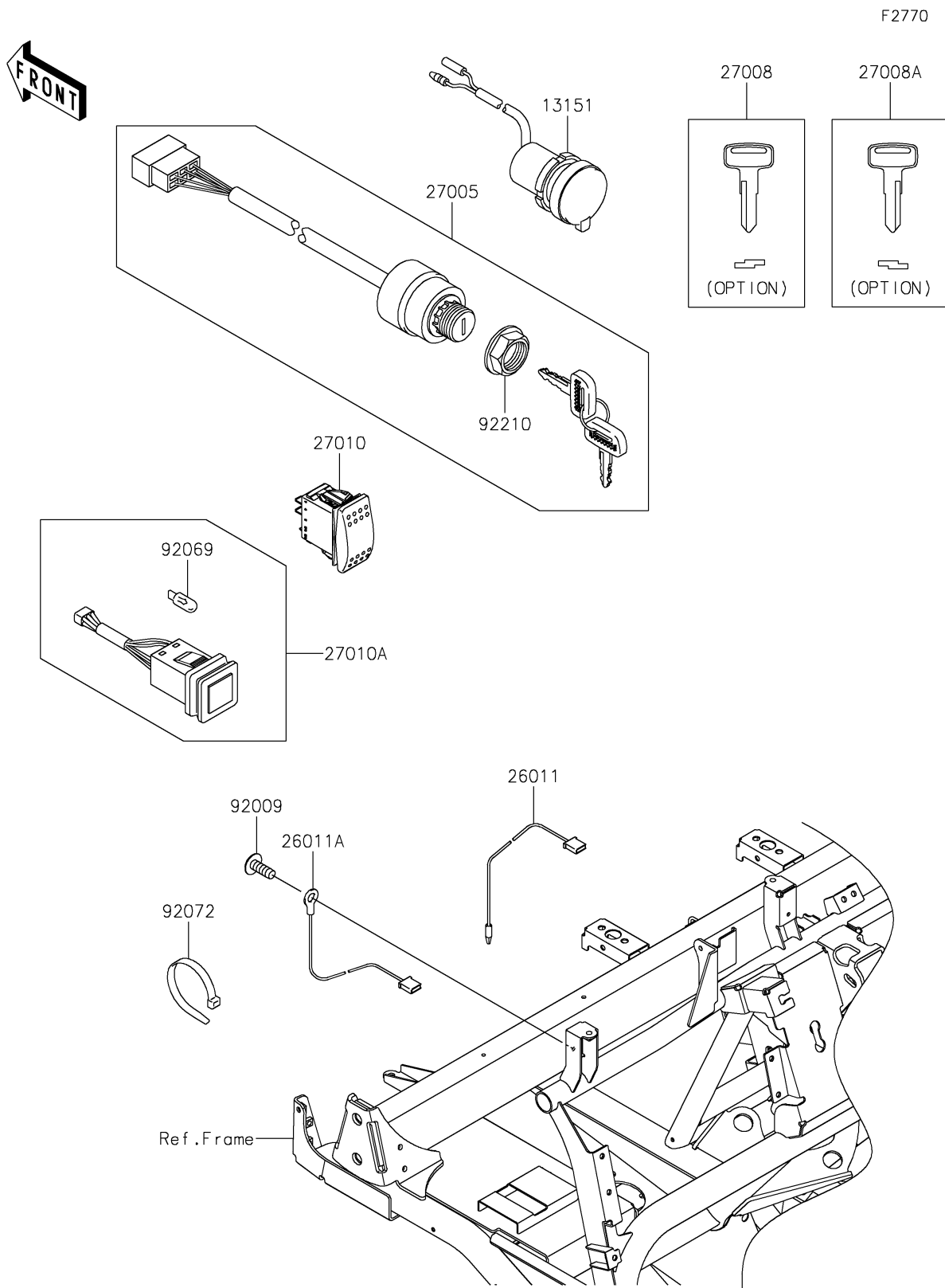

# 2018 MULE 4000 TRANS™

## PARTS LIST

### Ignition Switch

ITEM NAME	PART NUMBER	QUANTITY
-----------	-------------	----------

---