

2023 KX™ 250X

PARTS DIAGRAM

Oil Pump

E1710

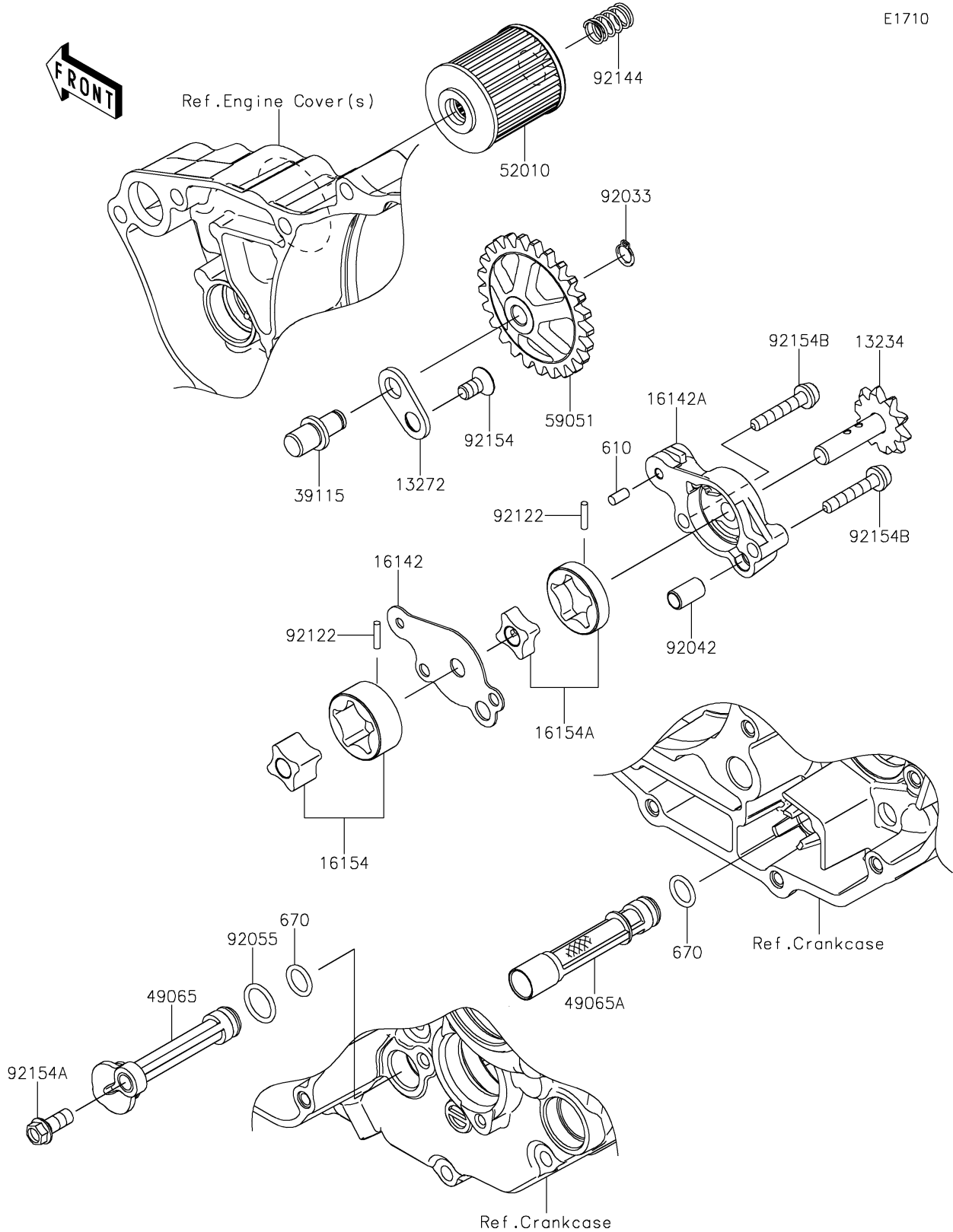

2023 KX™ 250X

PARTS LIST

Oil Pump

ITEM NAME	PART NUMBER	QUANTITY
SHAFT-COMP,OIL PUMP (Ref # 13234)	13234-0609	1
PLATE,OIL PUMP (Ref # 13272)	13272-2964	1
COVER-PUMP (Ref # 16142)	16142-0003	1
COVER-PUMP,FEED (Ref # 16142A)	16142-0761	1
ROTOR-PUMP,SCAVENGE (Ref # 16154)	16154-0759	1
ROTOR-PUMP,FEED (Ref # 16154A)	16154-0762	1
SHAFT-IDLER,OIL PUMP (Ref # 39115)	39115-0031	1
FILTER-OIL (Ref # 49065)	49065-0040	1
FILTER-OIL (Ref # 49065A)	49065-0043	1
ELEMENT-OIL FILTER (Ref # 52010)	52010-0001	1
GEAR-SPUR,PUMP IDLER (Ref # 59051)	59051-0009	1
RING-SNAP,8MM (Ref # 92033)	92033-1039	1
PIN,DOWEL,6.3X8X14 (Ref # 92042)	92042-007	1
RING-O,13.0X1.9 (Ref # 92055)	92055-1011	1
ROLLER,2.5X11.8 (Ref # 92122)	92122-0021	2
SPRING (Ref # 92144)	92144-1761	1
BOLT,TORX (Ref # 92154)	92154-1621	1
BOLT,FLANGED,6X14 (Ref # 92154A)	92154-2964	1
BOLT,SOCKET,5X28 (Ref # 92154B)	92154-4180	2
ROLLER,4X8 (Ref # 610)	610A0408	1
O RING,10MM (Ref # 670)	670D1510	2