

# 2023 NINJA® 400

## PARTS DIAGRAM

### Side Covers/Chain Cover

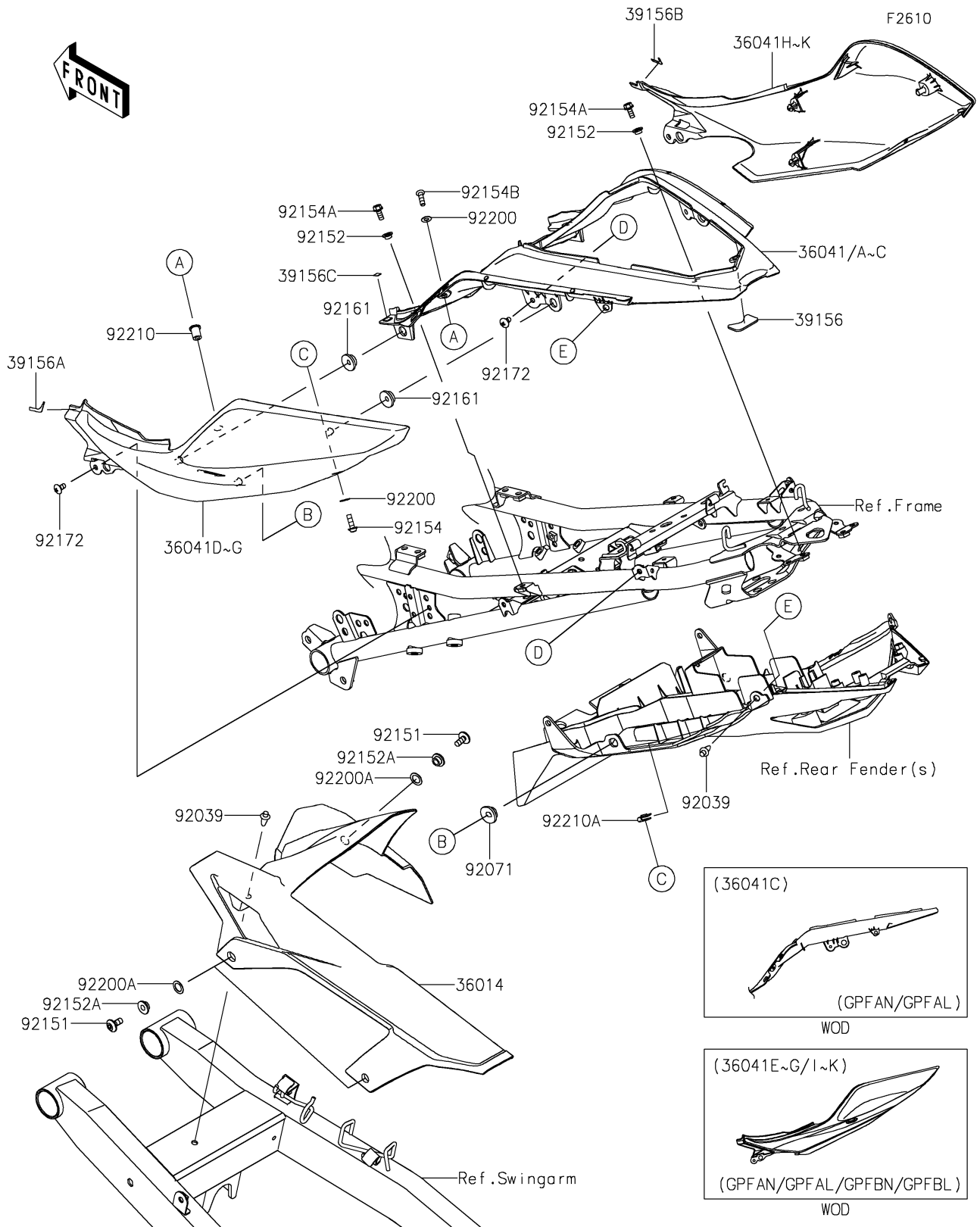

# 2023 NINJA<sup>®</sup> 400

## PARTS LIST

### Side Covers/Chain Cover

**ITEM NAME**

**PART NUMBER**

**QUANTITY**

---