

# 2022 NINJA® 400

## PARTS DIAGRAM

### Rear Fender(s)

F2172

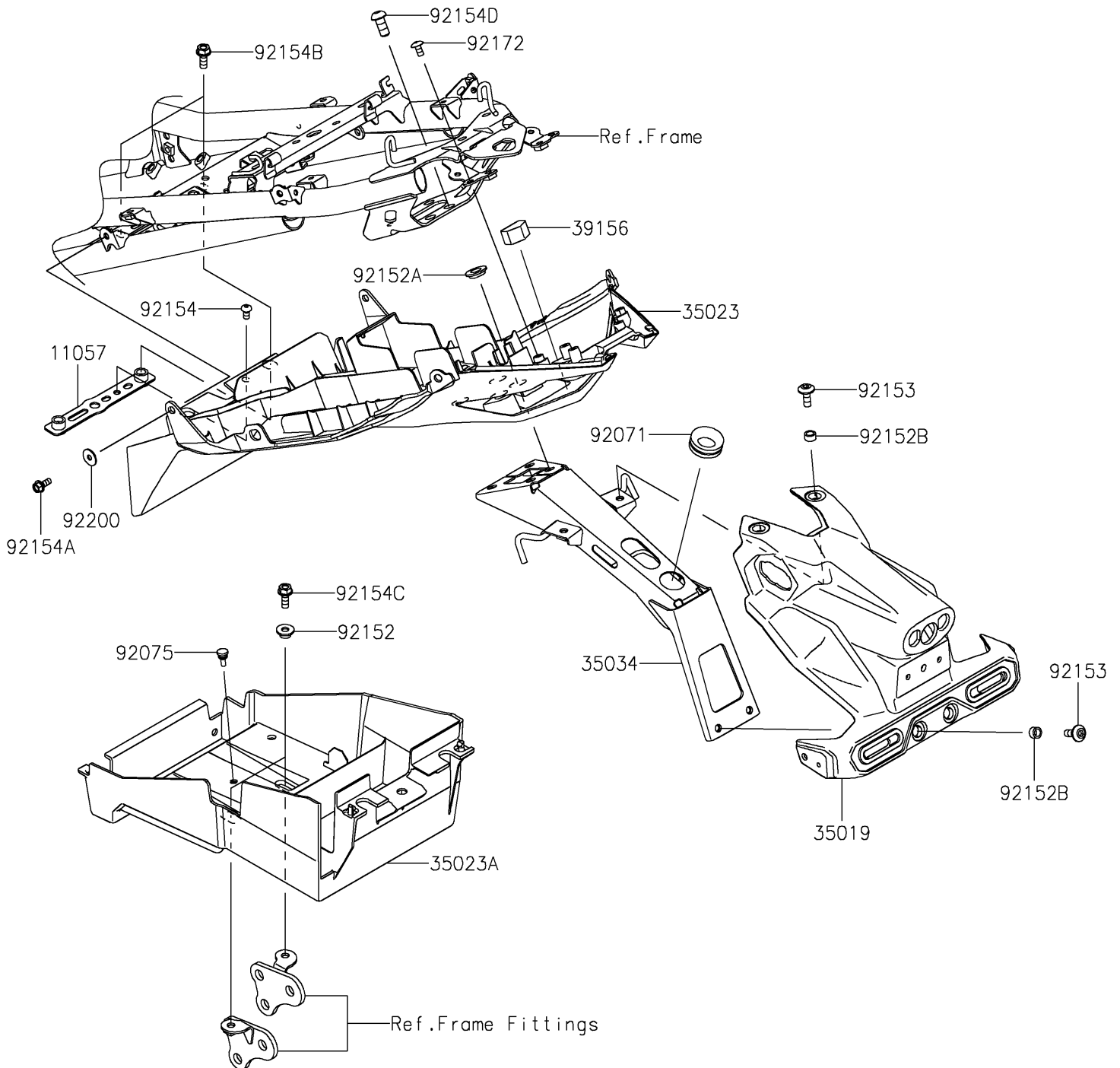

# 2022 NINJA® 400

## PARTS LIST

### Rear Fender(s)

ITEM NAME	PART NUMBER	QUANTITY
BRACKET (Ref # 11057)	11057-1191	1
FLAP (Ref # 35019)	35019-0639	1
FENDER-REAR (Ref # 35023)	35023-0436	1
FENDER-REAR (Ref # 35023A)	35023-0438	1
REINFORCE (Ref # 35034)	35034-0601	1
PAD,16X24X13 (Ref # 39156)	39156-2379	1
GROMMET (Ref # 92071)	92071-0709	1
DAMPER,6X10X15 (Ref # 92075)	92075-1808	1
COLLAR,6.5X10X6.4 (Ref # 92152)	92152-2287	2
COLLAR,10X20X4.5 (Ref # 92152A)	92152-2392	4
COLLAR,6.8X10X5.4 (Ref # 92152B)	92152-2393	4
BOLT,SOCKET,6X16 (Ref # 92153)	92153-1526	4
BOLT,SOCKET,5X10 (Ref # 92154)	92154-1547	1
BOLT,FLANGED,5X12 (Ref # 92154A)	92154-2893	2
BOLT,FLANGED,6X16 (Ref # 92154B)	92154-2895	2
BOLT,FLANGED,6X16 (Ref # 92154C)	92154-2900	2
BOLT,SOCKET,8X18 (Ref # 92154D)	92154-3739	4
SCREW,TAPPING,5X10 (Ref # 92172)	92172-0262	2
WASHER,5.2X16X1.2 (Ref # 92200)	92200-0583	2