

# 2022 NINJA® 400

## PARTS DIAGRAM

### Crankcase

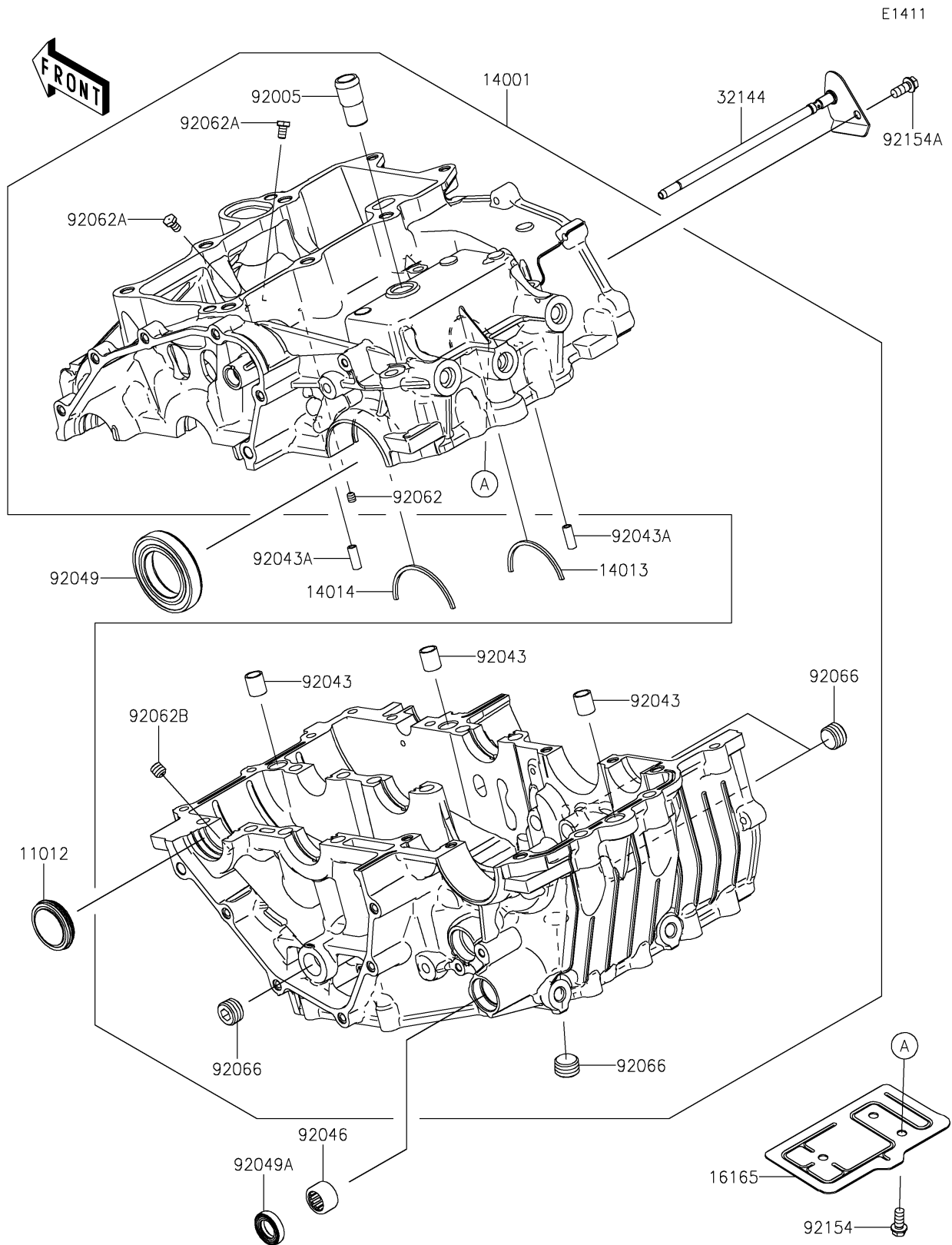

# 2022 NINJA® 400

## PARTS LIST

### Crankcase

**ITEM NAME**

**PART NUMBER**

**QUANTITY**

---