

# 2021 NINJA® 400 ABS

## PARTS DIAGRAM

### Seat

F2510

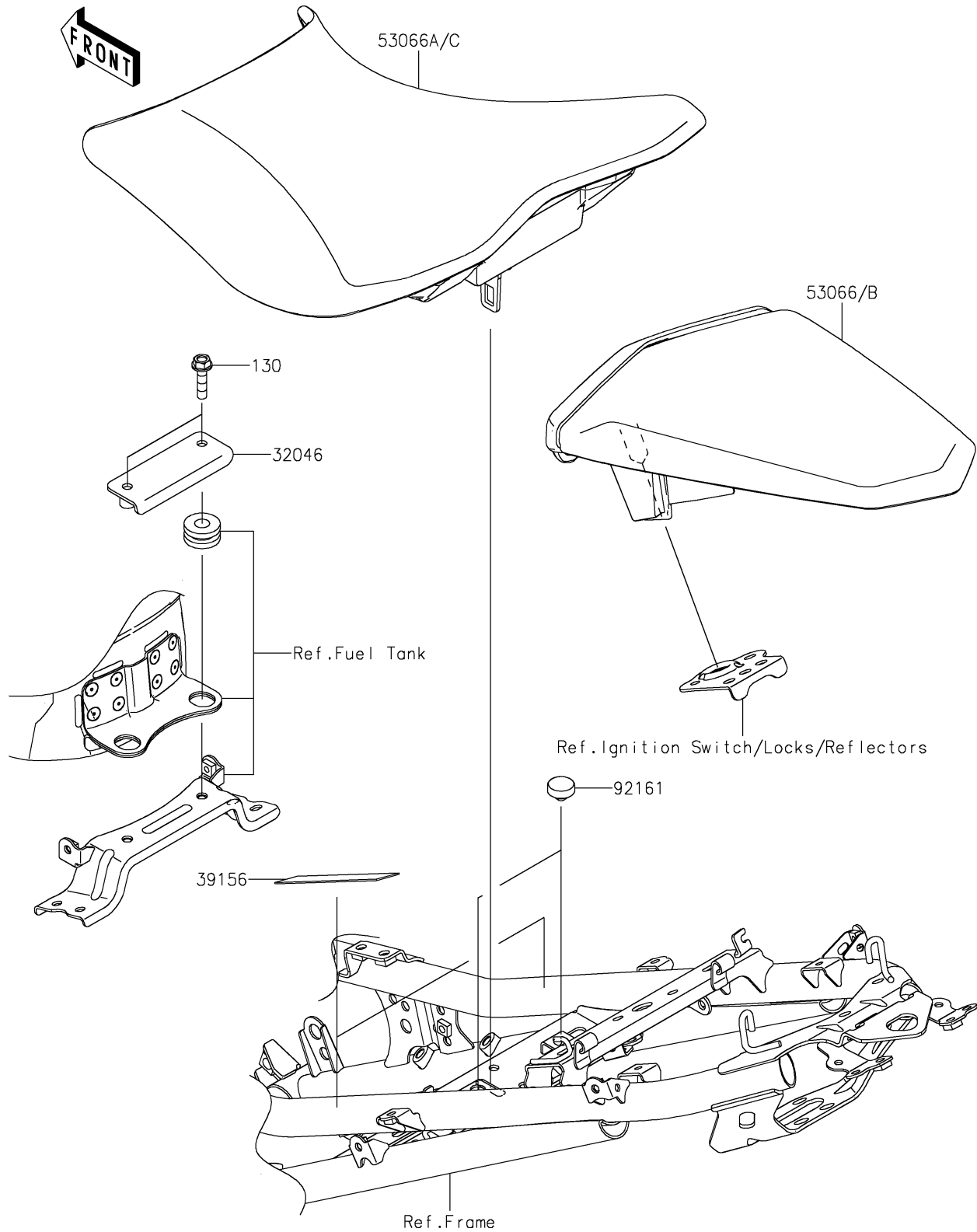

# 2021 NINJA<sup>®</sup> 400 ABS

## PARTS LIST

Seat

**ITEM NAME**

**PART NUMBER**

**QUANTITY**

---