

# 1997 Eliminator 600

## PARTS DIAGRAM

### Frame

F2120

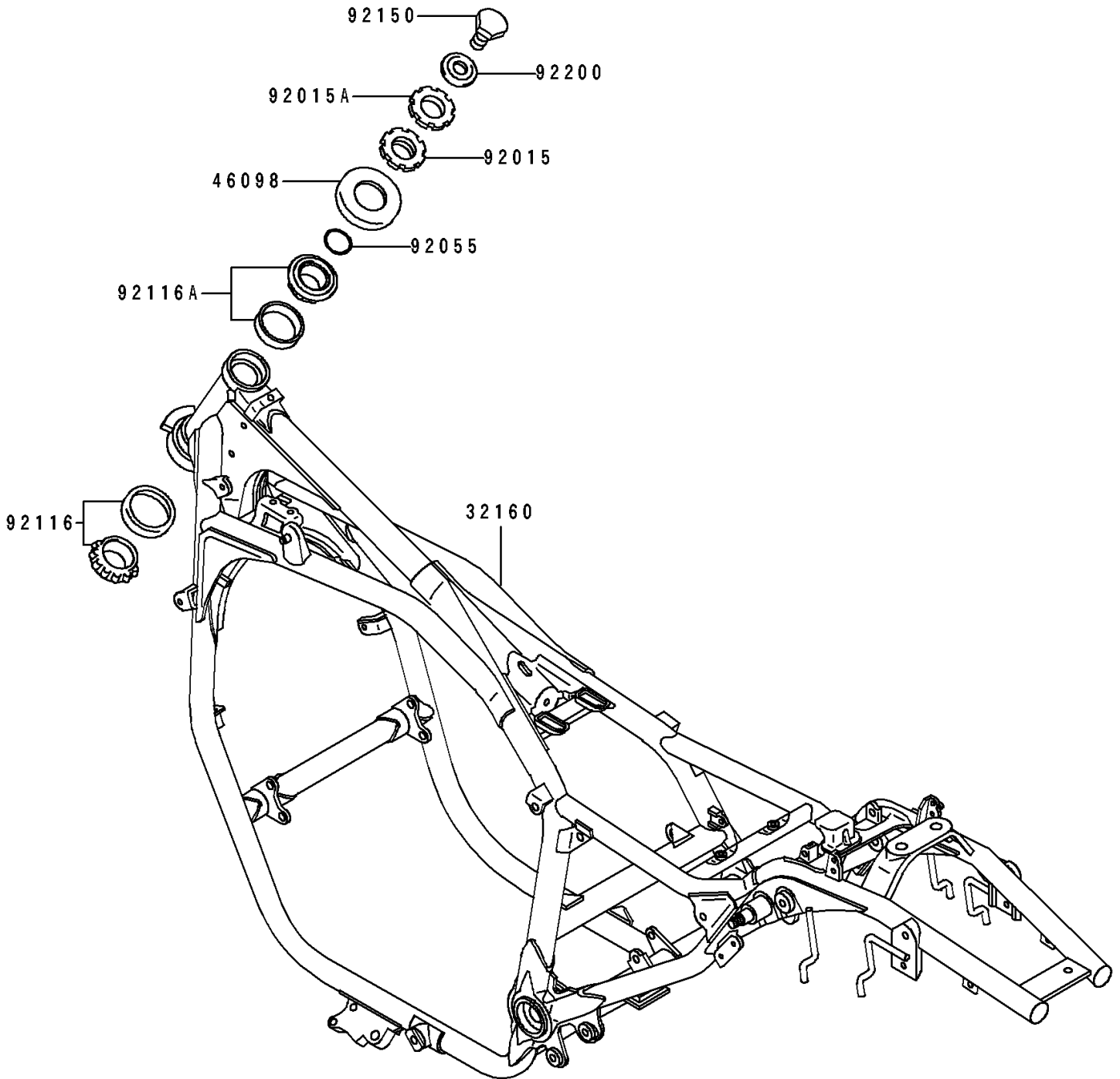

# 1997 Eliminator 600

## PARTS LIST

Frame

**ITEM NAME**

**PART NUMBER**

**QUANTITY**

---