

2000 Concours

PARTS DIAGRAM

Accessory

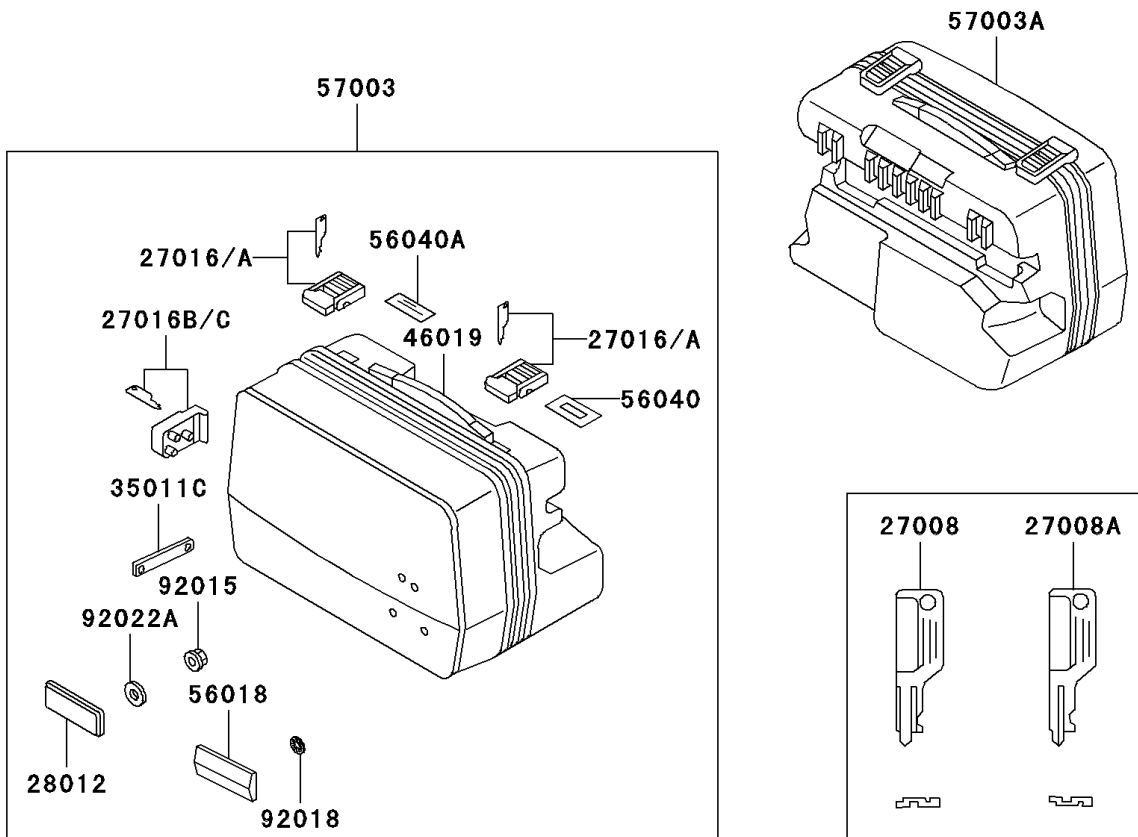
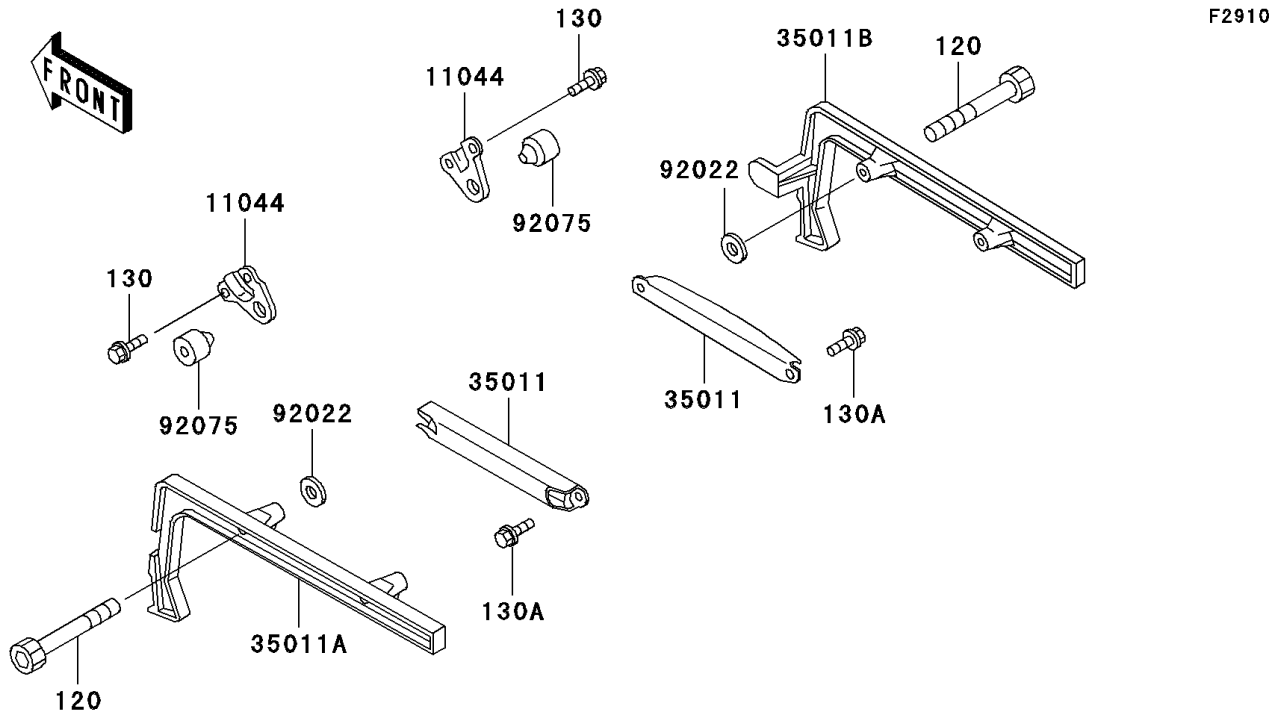

2000 Concours

PARTS LIST

Accessory

ITEM NAME

PART NUMBER

QUANTITY
