

2000 Concours

PARTS DIAGRAM

Camshaft(s)/Tensioner

E1230

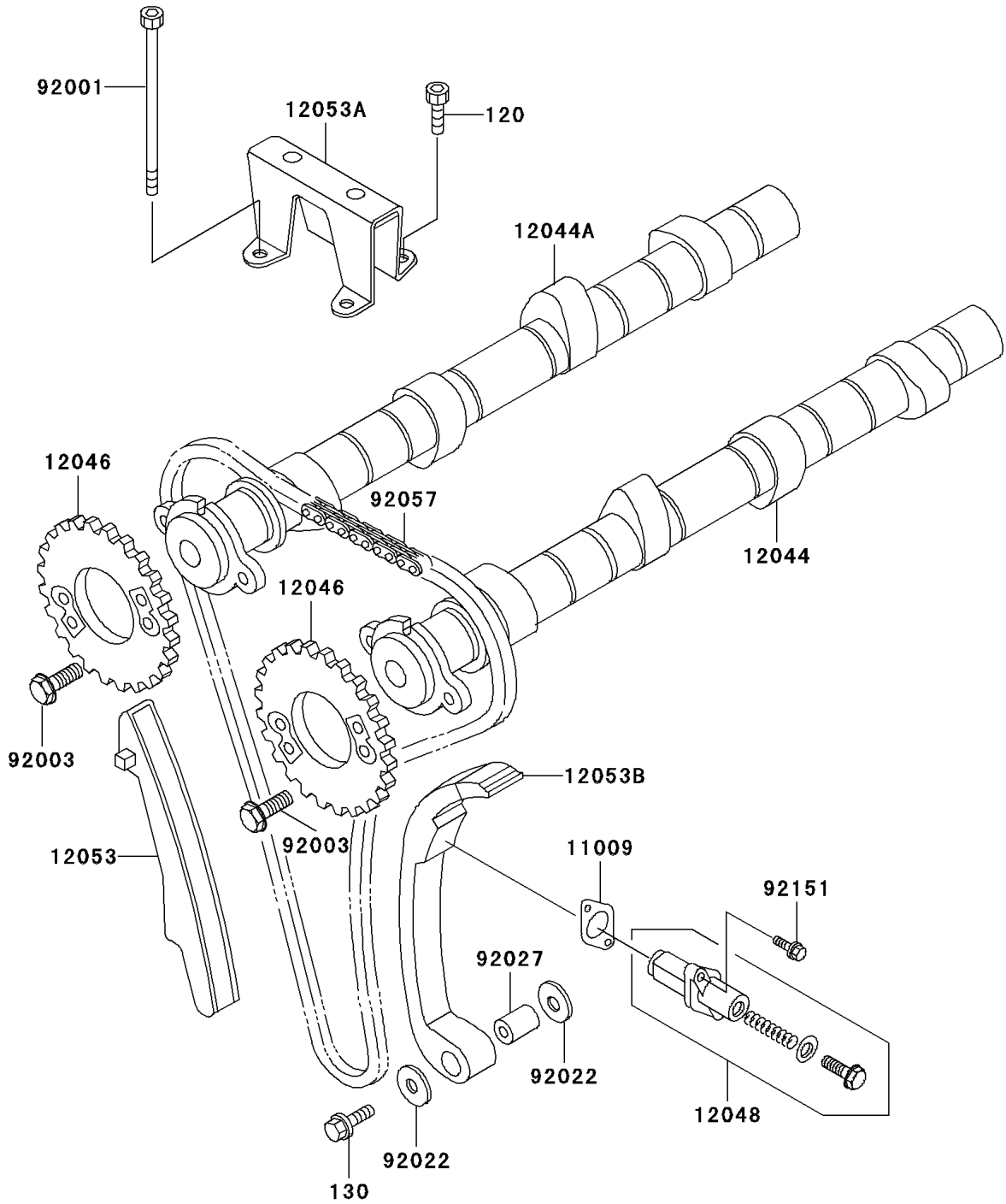

2000 Concours

PARTS LIST

Camshaft(s)/Tensioner

Kawasaki

Let the Good Times Roll®

ITEM NAME

PART NUMBER

QUANTITY
