

# 1998 Concours

## PARTS DIAGRAM

### Accessory

F2910

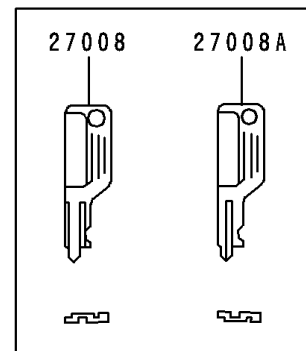
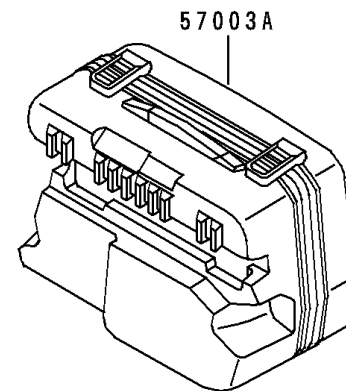
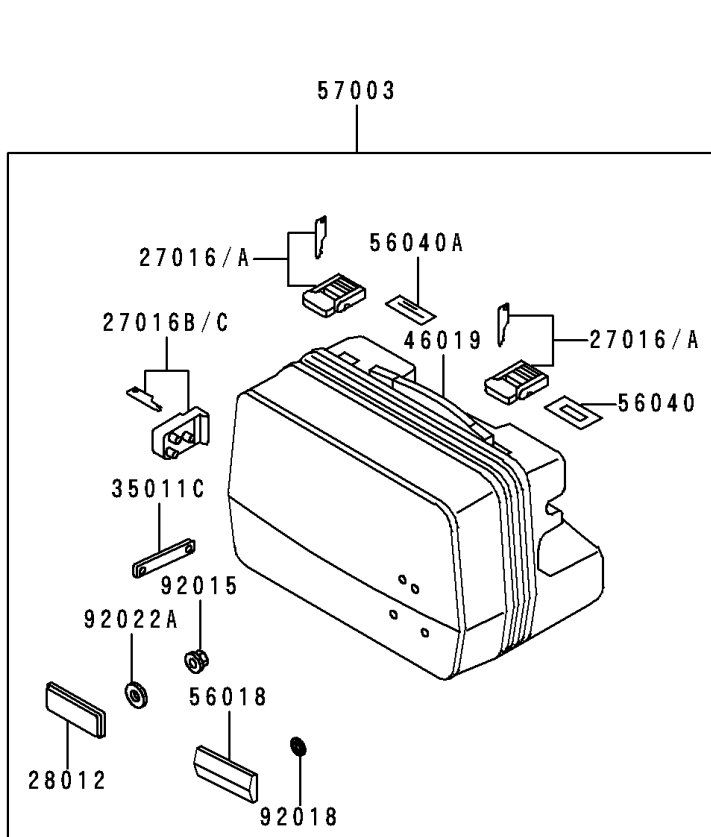
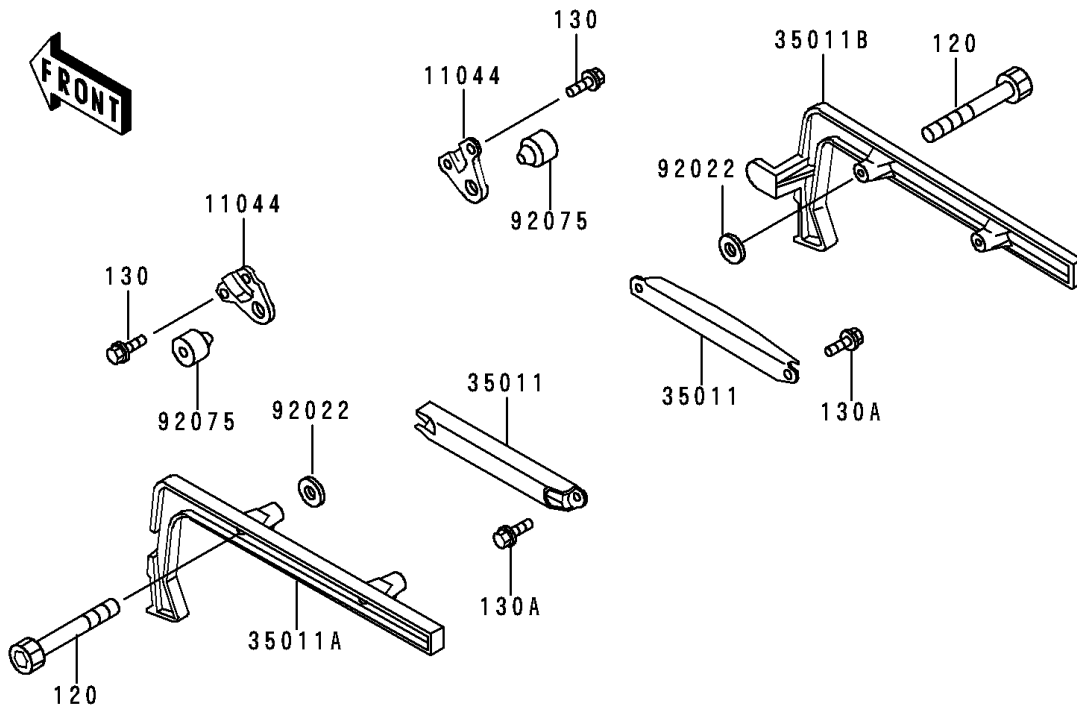

# 1998 Concours

## PARTS LIST

### Accessory

**ITEM NAME**

**PART NUMBER**

**QUANTITY**

---