

# 1998 Concours

## PARTS DIAGRAM

### Chassis Electrical Equipment

F2760

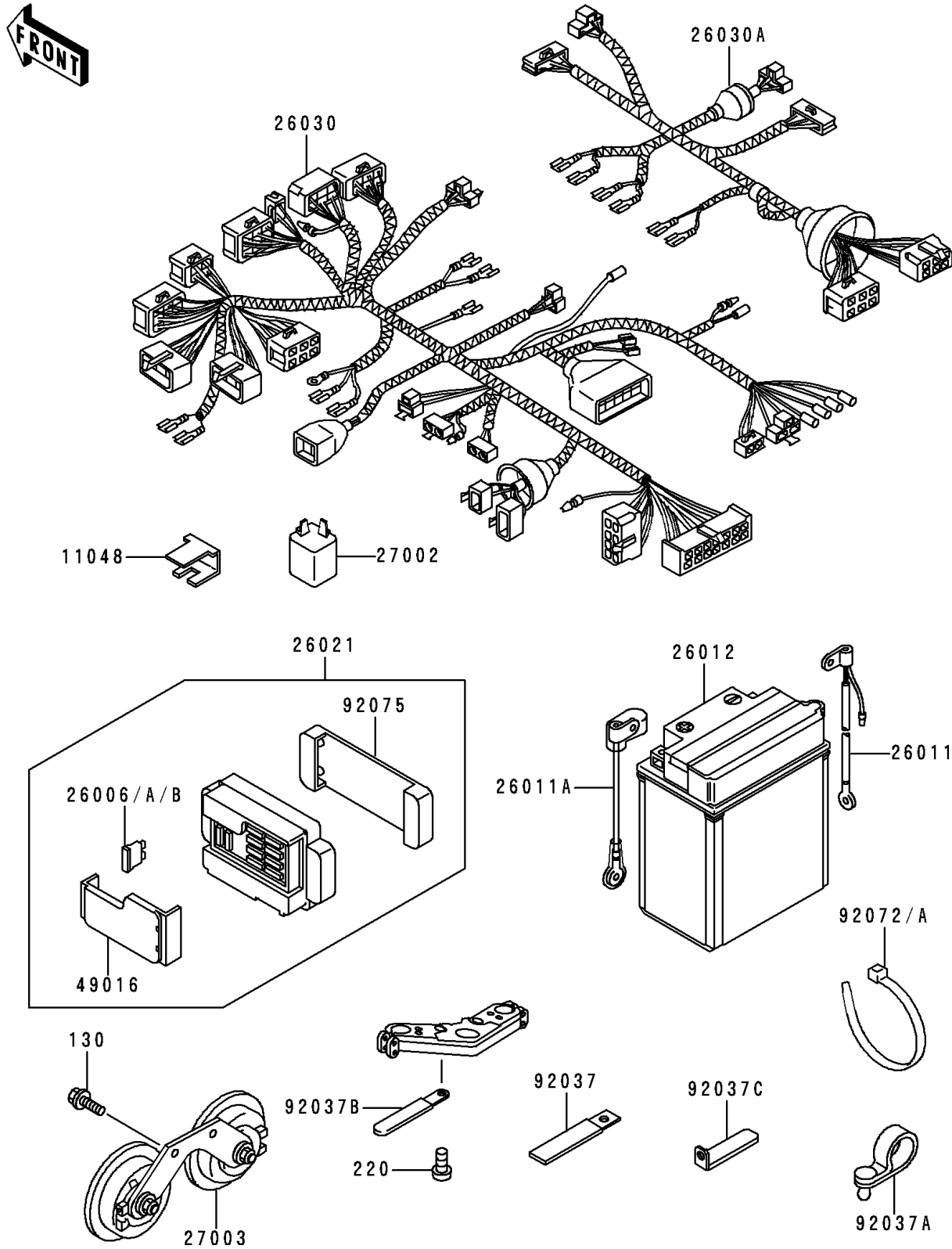

# 1998 Concours

## PARTS LIST

### Chassis Electrical Equipment

**ITEM NAME**

**PART NUMBER**

**QUANTITY**

---