

1999 Concours

PARTS DIAGRAM

Frame

F 21 20

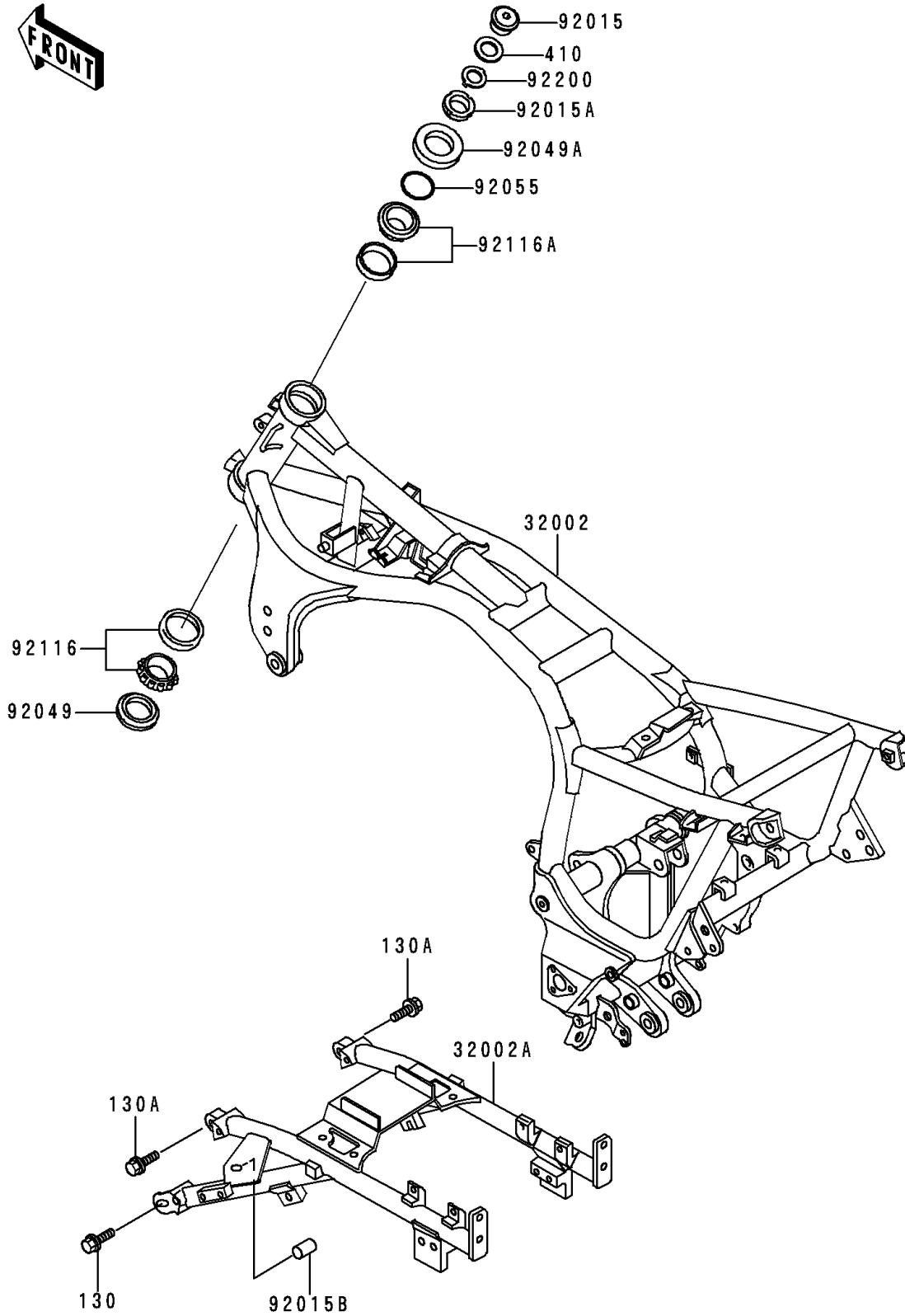

1999 Concours

PARTS LIST

Frame

ITEM NAME

PART NUMBER

QUANTITY
