

1999 Vulcan 750

PARTS DIAGRAM

Crankshaft

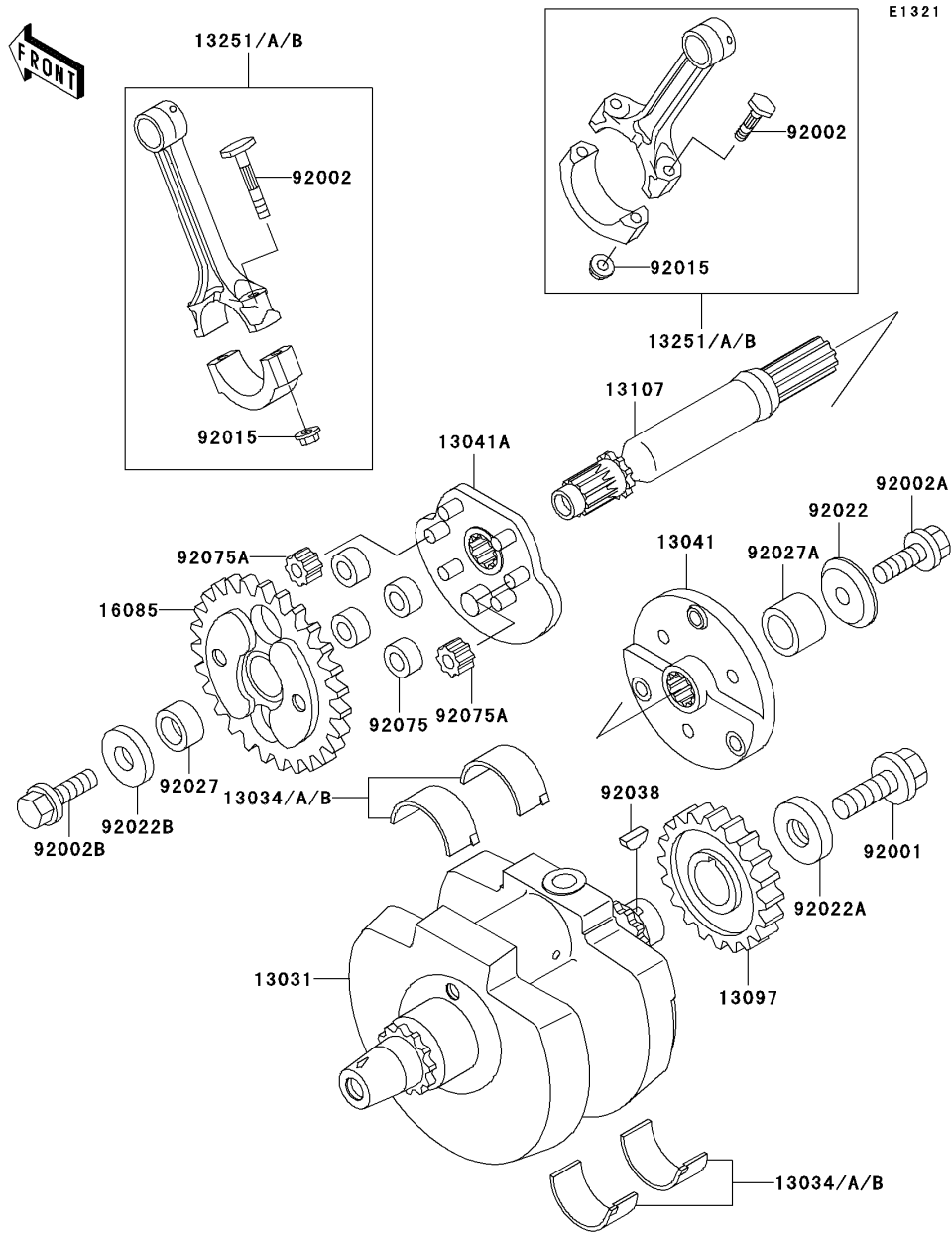

1999 Vulcan 750

PARTS LIST

Crankshaft

ITEM NAME

PART NUMBER

QUANTITY
