

1994 Vulcan 750

PARTS DIAGRAM

Taillight(s)

F 2720

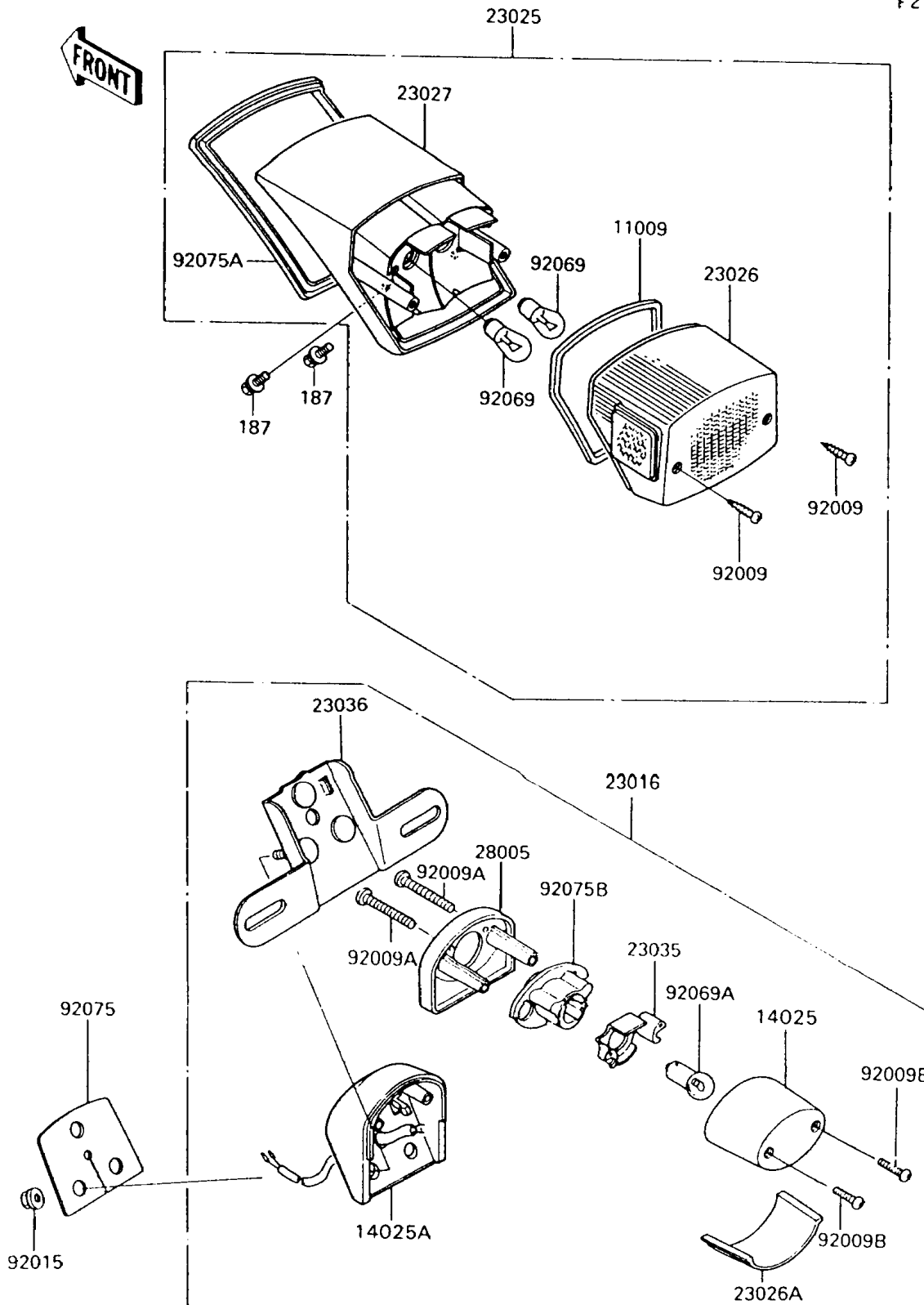

1994 Vulcan 750

PARTS LIST

Taillight(s)

ITEM NAME

PART NUMBER

QUANTITY
