

# 2009 Vulcan® 2000

## PARTS DIAGRAM

### Taillight(s)

F2720

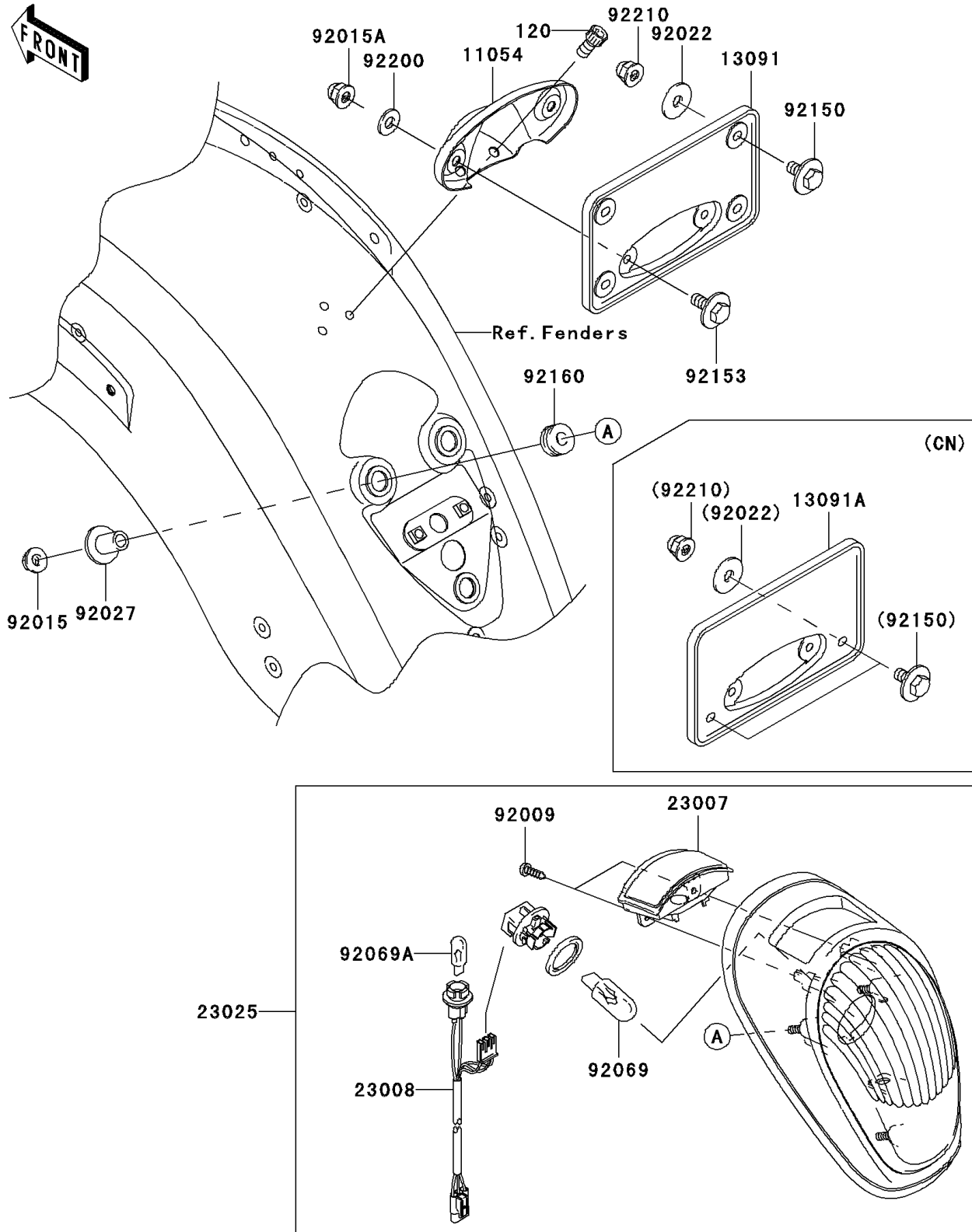

# 2009 Vulcan® 2000

## PARTS LIST

Taillight(s)

**ITEM NAME**

**PART NUMBER**

**QUANTITY**

---