

2022 KFX[®]90

PARTS DIAGRAM

Generator

E1810

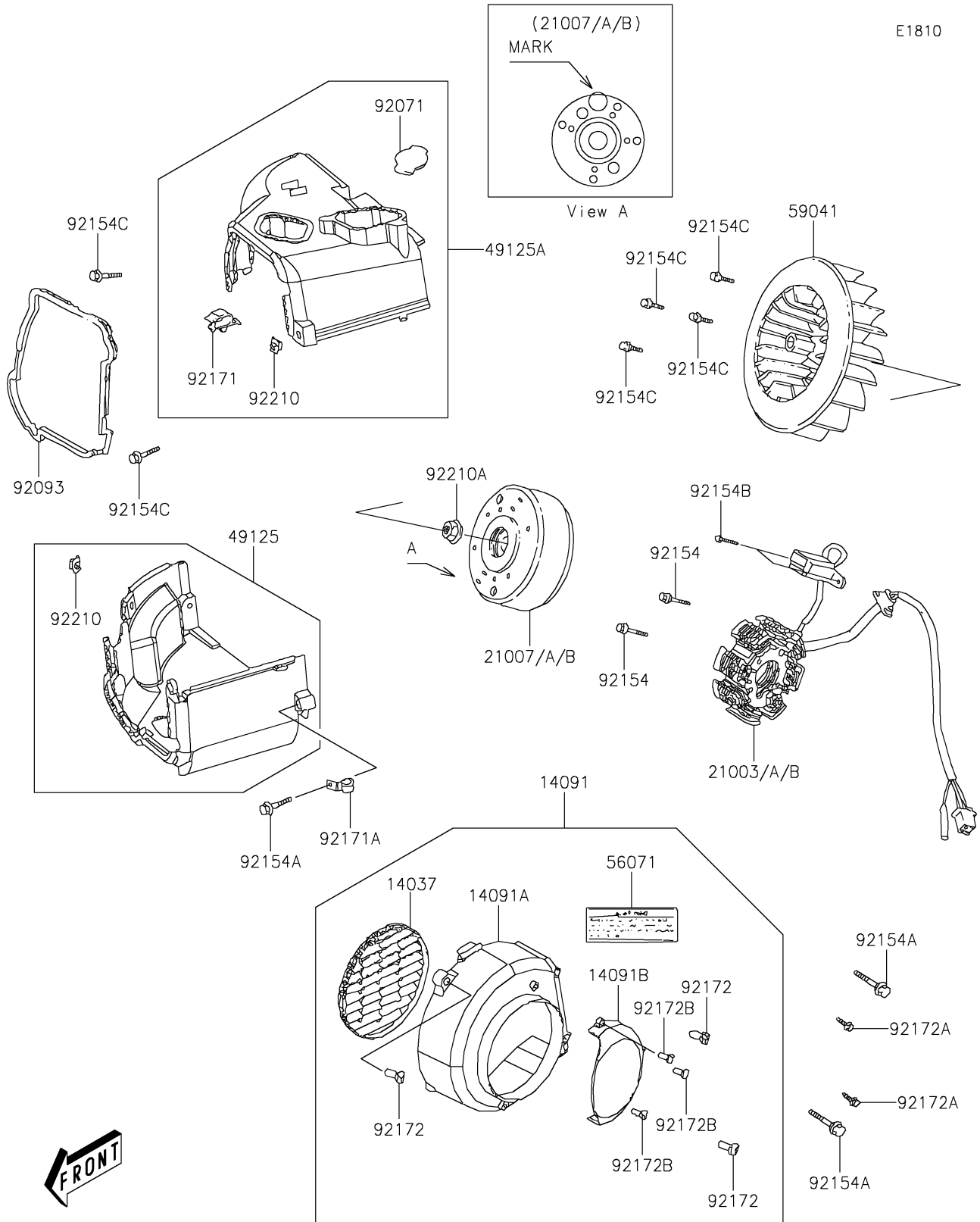

2022 KFX[®] 90

PARTS LIST

Generator

ITEM NAME	PART NUMBER	QUANTITY
SCREEN (Ref # 14037)	14037-Y002	1
COVER,FAN (Ref # 14091)	14091-Y003	1
COVER,FAN (Ref # 14091A)	14091-Y011	1
COVER (Ref # 14091B)	14091-Y012	1
STATOR,D402 (Ref # 21003)	21003-Y002	1
STATOR,D406 (Ref # 21003A)	21003-Y005	1
STATOR,D414 (Ref # 21003B)	21003-Y006	1
ROTOR,D402 (Ref # 21007)	21007-Y001	1
ROTOR,D406 (Ref # 21007A)	21007-Y005	1
ROTOR,D414 (Ref # 21007B)	21007-Y006	1
SHROUD,LWR (Ref # 49125)	49125-Y002	1
SHROUD,UPP (Ref # 49125A)	49125-Y004	1
LABEL-WARNING (Ref # 56071)	56071-Y002	1
FAN (Ref # 59041)	59041-Y001	1
GROMMET (Ref # 92071)	92071-Y001	1
SEAL,SHROUD (Ref # 92093)	92093-Y004	1
BOLT,6X20 (Ref # 92154)	92154-Y057	2
BOLT,FLANGE,6X25 (Ref # 92154A)	92154-Y066	3
BOLT,HEX,5X12 (Ref # 92154B)	92154-Y111	2
BOLT,FLANGE,6X16 (Ref # 92154C)	92154-Y134	6
CLAMP (Ref # 92171)	92171-Y001	1
CLAMP (Ref # 92171A)	92171-Y002	1
SCREW,4X12 (Ref # 92172)	92172-Y019	3
SCREW,5X16 (Ref # 92172A)	92172-Y021	2
SCREW,4X10 (Ref # 92172B)	92172-Y024	3
NUT,6MM (Ref # 92210)	92210-Y011	2
NUT,10MM (Ref # 92210A)	92210-Y029	1