

# 2022 KLX<sup>®</sup> 230 S

## PARTS DIAGRAM

### Throttle

E1510

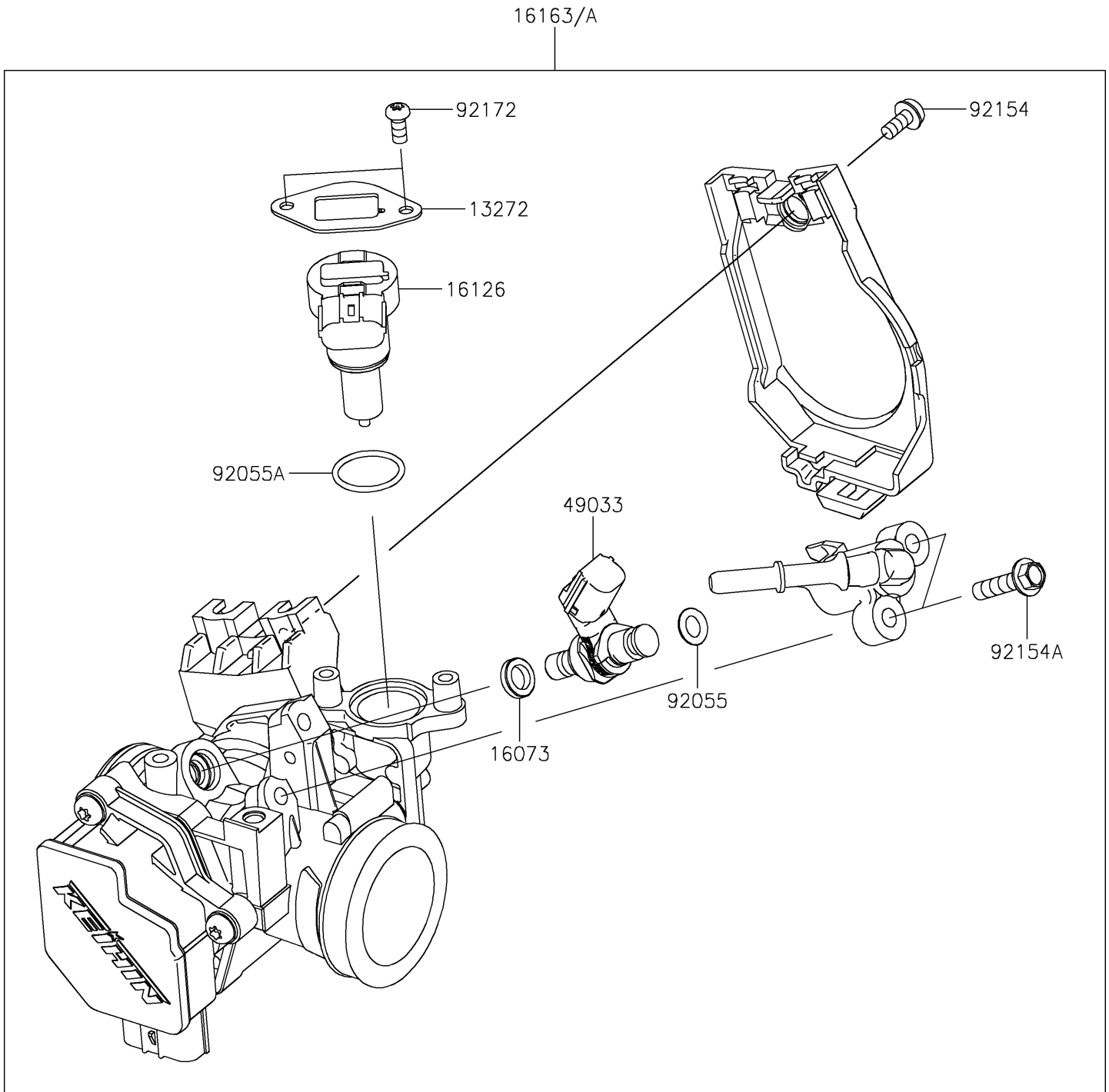

# 2022 KLX<sup>®</sup> 230 S

## PARTS LIST

### Throttle

**ITEM NAME**

**PART NUMBER**

**QUANTITY**

---