

# 2011 JET SKI® Ultra® LX

## PARTS DIAGRAM

Meters

F3179

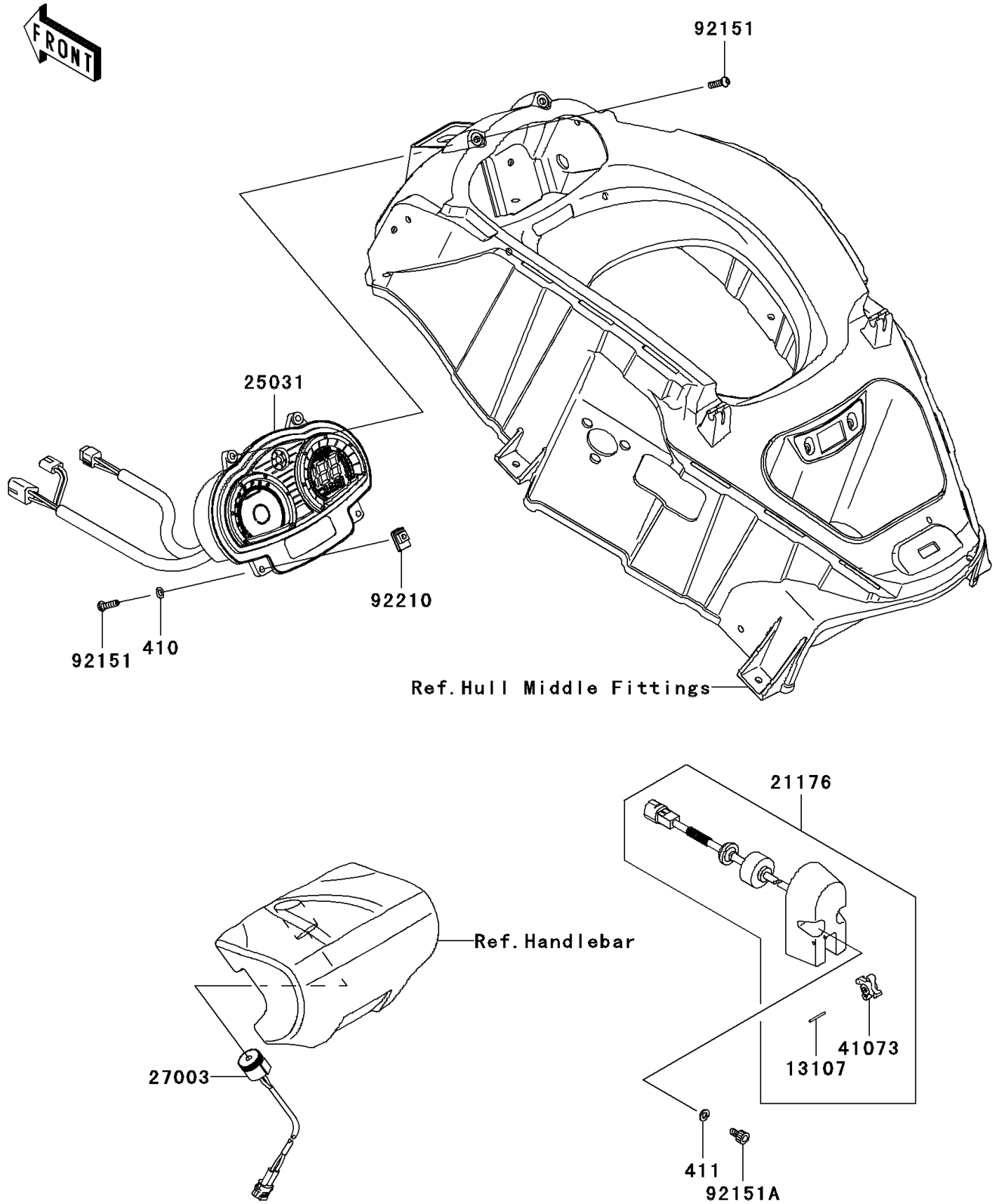

# 2011 JET SKI® Ultra® LX

## PARTS LIST

Meters



**ITEM NAME**

**PART NUMBER**

**QUANTITY**

---