

# 2022 Z H2

## PARTS DIAGRAM

### Accessory(Grip Heater)

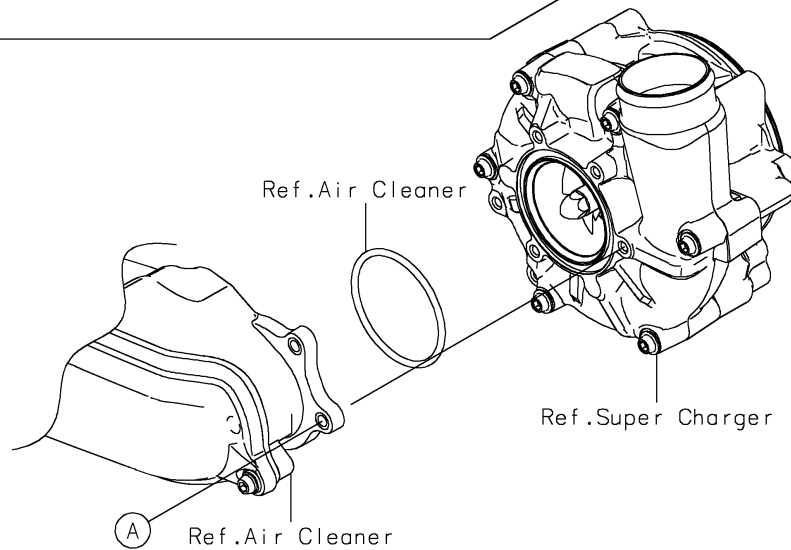
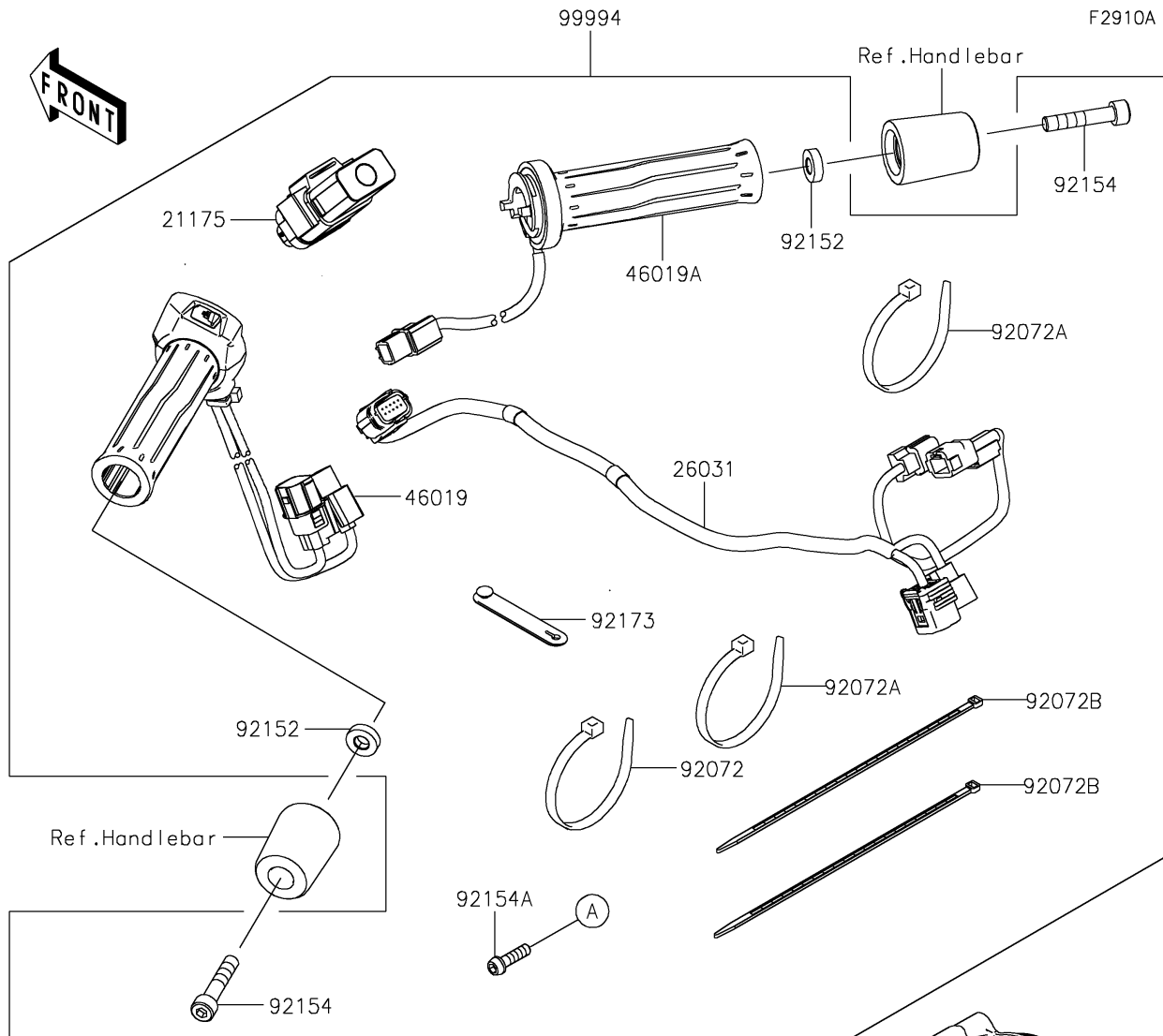

# 2022 Z H2

## PARTS LIST

Accessory(Grip Heater)

**ITEM NAME**

**PART NUMBER**

**QUANTITY**

---