

# 2022 Z H2

## PARTS DIAGRAM

### Tires

F2210

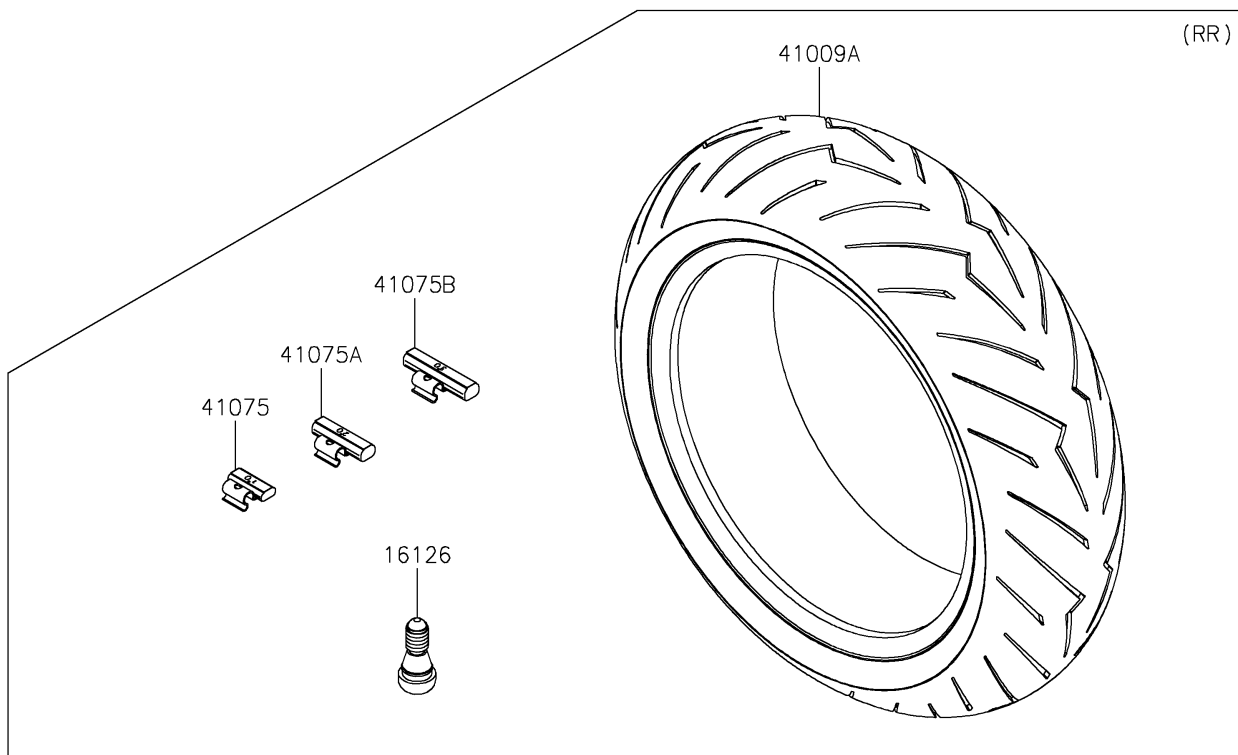
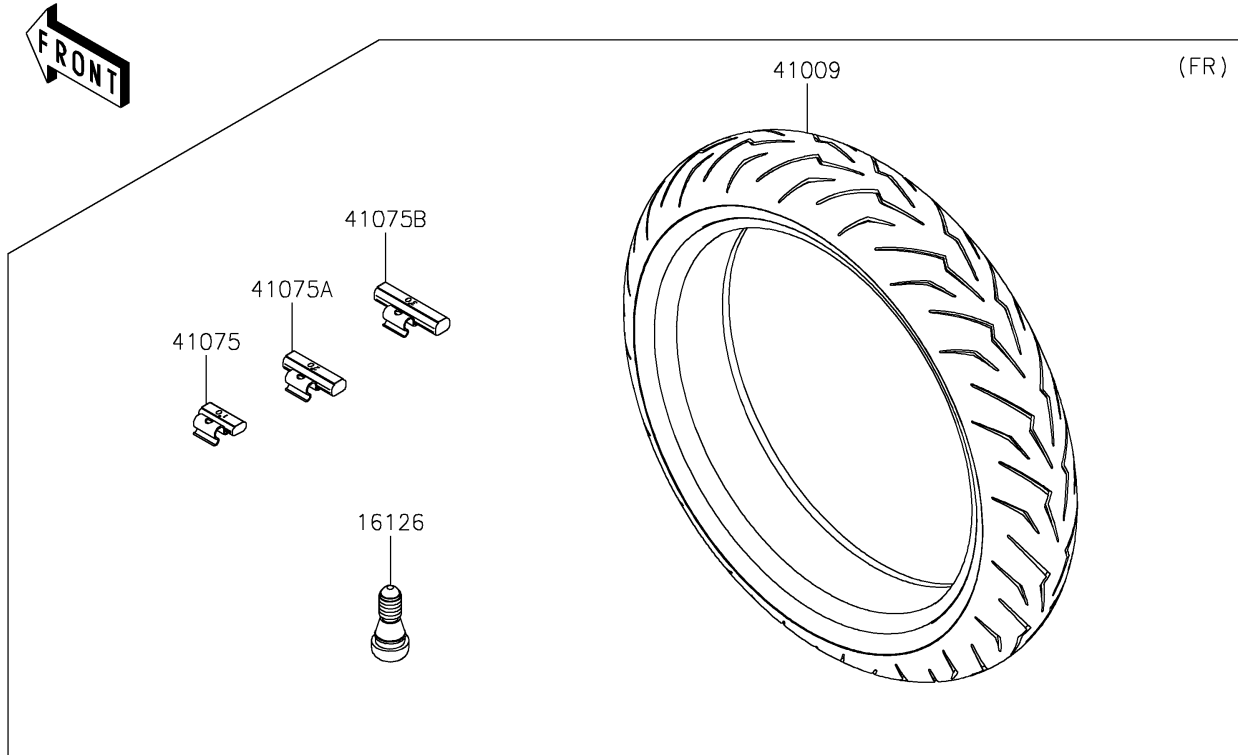

# 2022 Z H2

## PARTS LIST

### Tires

**ITEM NAME**

**PART NUMBER**

**QUANTITY**

---