

2021 JET SKI® STX®160

PARTS DIAGRAM

Hull

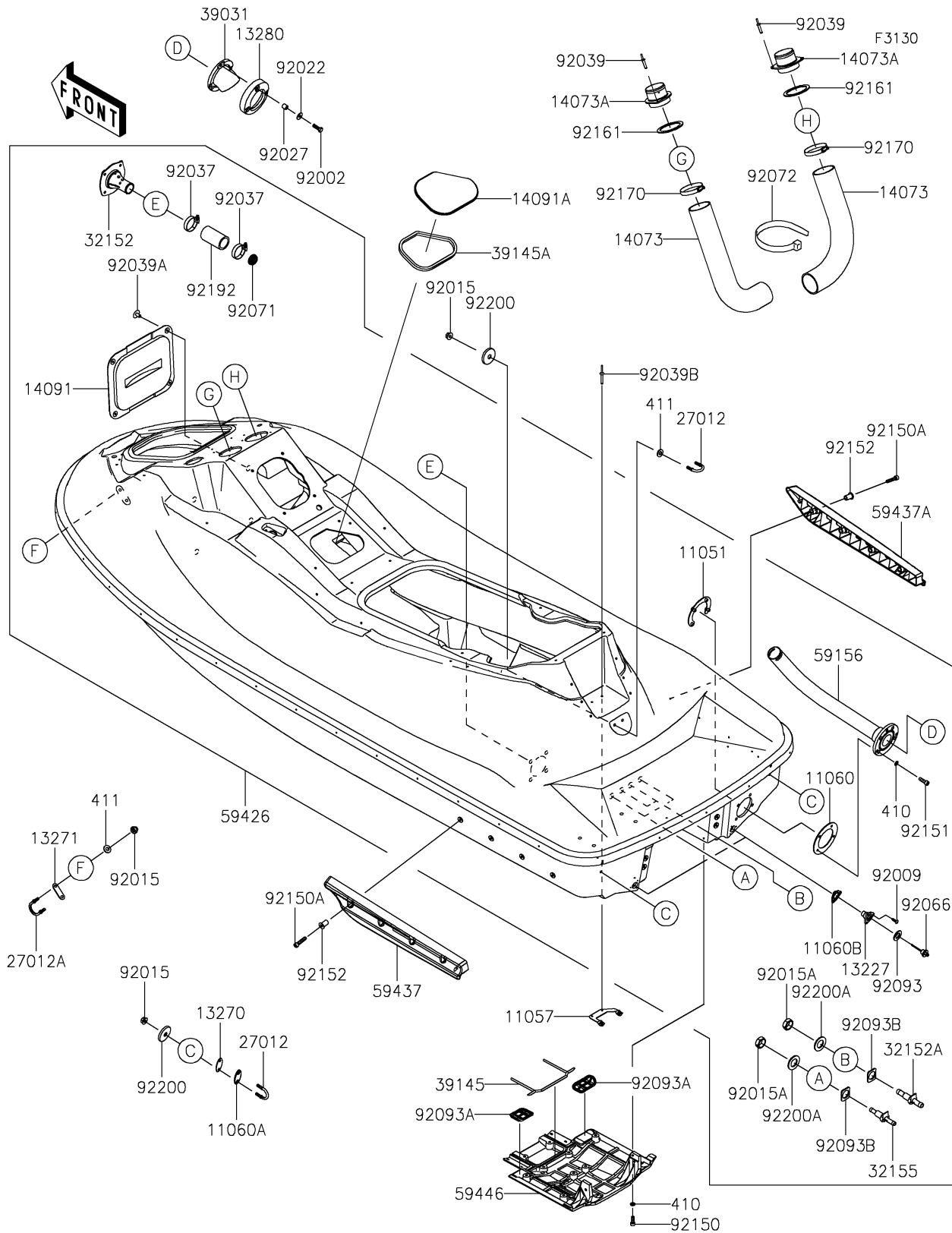

2021 JET SKI® STX®160

PARTS LIST

Hull

ITEM NAME	PART NUMBER	QUANTITY
BRACKET (Ref # 11051)	11051-3731	1
BRACKET,BREATHER (Ref # 11057)	11057-2807	1
GASKET (Ref # 11060)	11060-3781	1
GASKET,U HOOK,RR (Ref # 11060A)	11060-3800	2
GASKET,DRAIN PLUG (Ref # 11060B)	11060-3801	2
HOUSING,DRAIN PLUG,F.BLACK (Ref # 13227)	13227-3721-6Z	2
PLATE (Ref # 13270)	13270-3860	2
PLATE (Ref # 13271)	13271-3724	1
HOLDER,EXHAUST VALVE (Ref # 13280)	13280-3718	1
DUCT (Ref # 14073)	14073-0868	2
DUCT (Ref # 14073A)	14073-3805	2
COVER,ECU (Ref # 14091)	14091-3786	1
COVER,CNT ACCESS (Ref # 14091A)	14091-3800	1
HOOK (Ref # 27012)	27012-3797	3
HOOK (Ref # 27012A)	27012-3821	1
PIPE,DRIVE SHAFT (Ref # 32152)	32152-3703	1
PIPE (Ref # 32152A)	32152-3749	2
PIPE,COOLING (Ref # 32155)	32155-1511	2
CAP-END (Ref # 39031)	39031-3704	1
TRIM-SEAL,JET PUMP COVER (Ref # 39145)	39145-3768	1
TRIM-SEAL,8.5X11X592 (Ref # 39145A)	39145-3800	1
PIPE-TAIL (Ref # 59156)	59156-3740	1
HULL-COMP,BLACK+WHT (Ref # 59426)	59426-0013-43G	1
STABILIZER,LH,F.BLACK (Ref # 59437)	59437-3745-6Z	1
STABILIZER,RH,F.BLACK (Ref # 59437A)	59437-3746-6Z	1
COVER-JET PUMP (Ref # 59446)	59446-0078	1
BOLT,6X20 (Ref # 92002)	92002-3755	3
SCREW,TAPPING,4X16 (Ref # 92009)	92009-3849	6
NUT,FLANGED,8MM (Ref # 92015)	92015-1933	8

2021 JET SKI® STX®160

PARTS LIST

Hull

ITEM NAME	PART NUMBER	QUANTITY
NUT,20MM (Ref # 92015A)	92015-3738	4
WASHER (Ref # 92022)	92022-567	3
COLLAR,6.2X10X10 (Ref # 92027)	92027-3705	3
CLAMP (Ref # 92037)	92037-3009	2
RIVET (Ref # 92039)	92039-3775	4
RIVET (Ref # 92039A)	92039-3785	4
RIVET (Ref # 92039B)	92039-3794	2
PLUG,RR,DRAIN,F.BLACK (Ref # 92066)	92066-3783-6Z	2
GROMMET (Ref # 92071)	92071-1259	1
BAND,L=608.22 (Ref # 92072)	92072-3884	1
SEAL (Ref # 92093)	92093-3720	2
SEAL (Ref # 92093A)	92093-3765	2
SEAL (Ref # 92093B)	92093-3784	4
BOLT,SOCKET,6X18 (Ref # 92150)	92150-3775	10
BOLT,SOCKET,6X30 (Ref # 92150A)	92150-3822	8
BOLT,SOCKET,6X20 (Ref # 92151)	92151-3774	4
COLLAR (Ref # 92152)	92152-3715	8
DAMPER (Ref # 92161)	92161-3769	2
CLAMP (Ref # 92170)	92170-1679	2
TUBE,39X51X90 (Ref # 92192)	92192-1511	1
WASHER (Ref # 92200)	92200-3779	6
WASHER,21X34X2 (Ref # 92200A)	92200-3802	4
WASHER-PLAIN-SMALL,6MM (Ref # 410)	410S0600	14
WASHER-PLAIN,8MM (Ref # 411)	411S0800	4