

# 2023 JET SKI® STX® 160

## PARTS DIAGRAM

### Crankcase

E1411

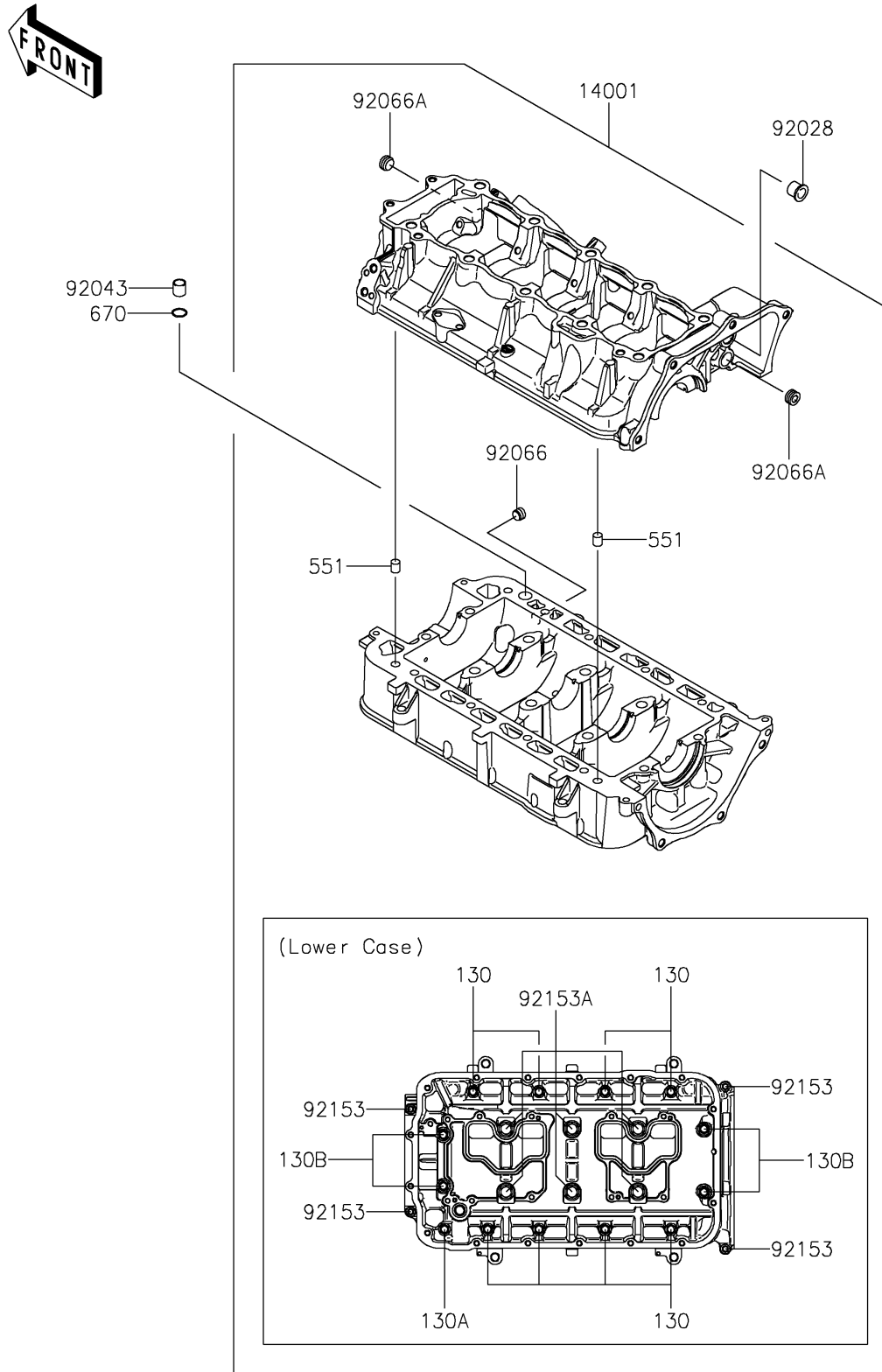

# 2023 JET SKI® STX® 160

## PARTS LIST

### Crankcase

**ITEM NAME**

**PART NUMBER**

**QUANTITY**

---