

# 2022 MULE PRO-FXT™ EPS CAMO

## PARTS DIAGRAM

### Crankcase

E1411

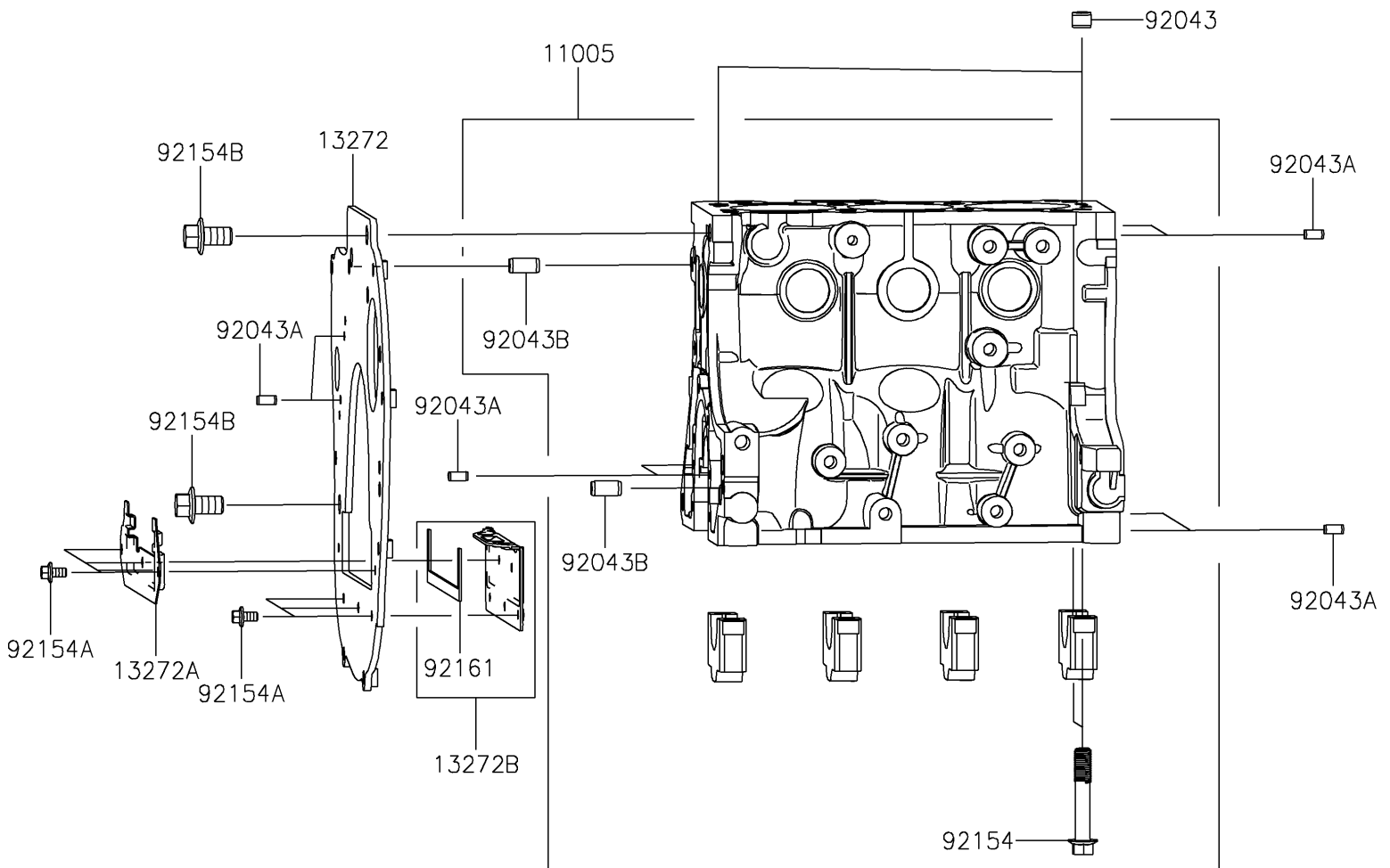

# 2022 MULE PRO-FXT™ EPS CAMO

## PARTS LIST

### Crankcase

ITEM NAME	PART NUMBER	QUANTITY
-----------	-------------	----------

---