

# 2021 MULE PRO-FX™ EPS LE

## PARTS DIAGRAM

### Decals

F2861

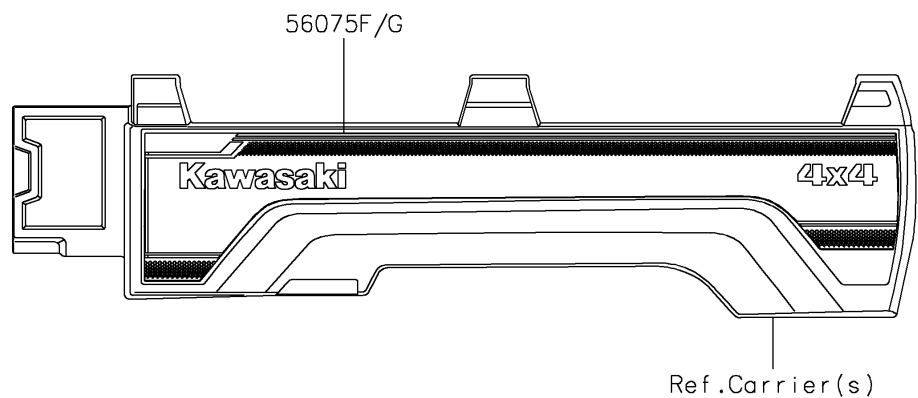
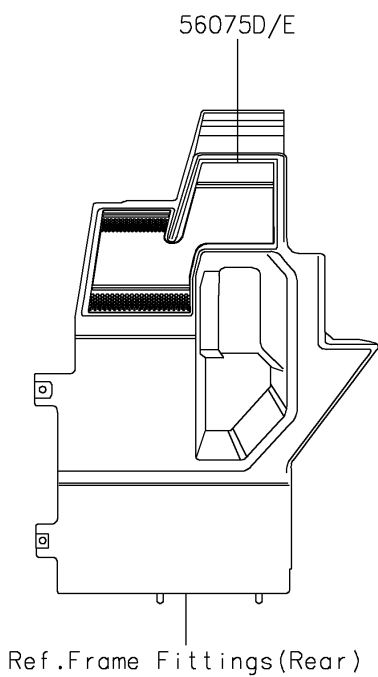
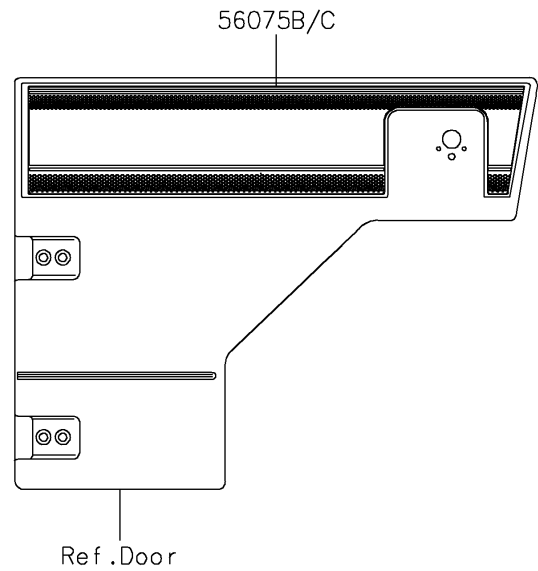
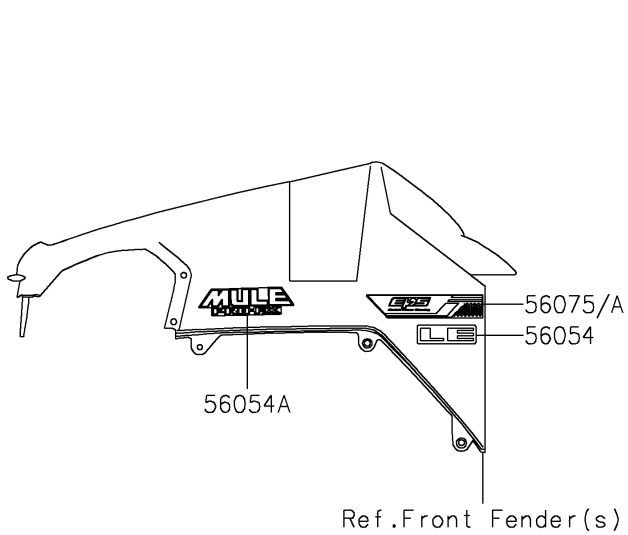

# 2021 MULE PRO-FX™ EPS LE

## PARTS LIST

### Decals

**ITEM NAME**

**PART NUMBER**

**QUANTITY**

---