

# 2022 MULE PRO-FX™ EPS LE

## PARTS DIAGRAM

### Cables

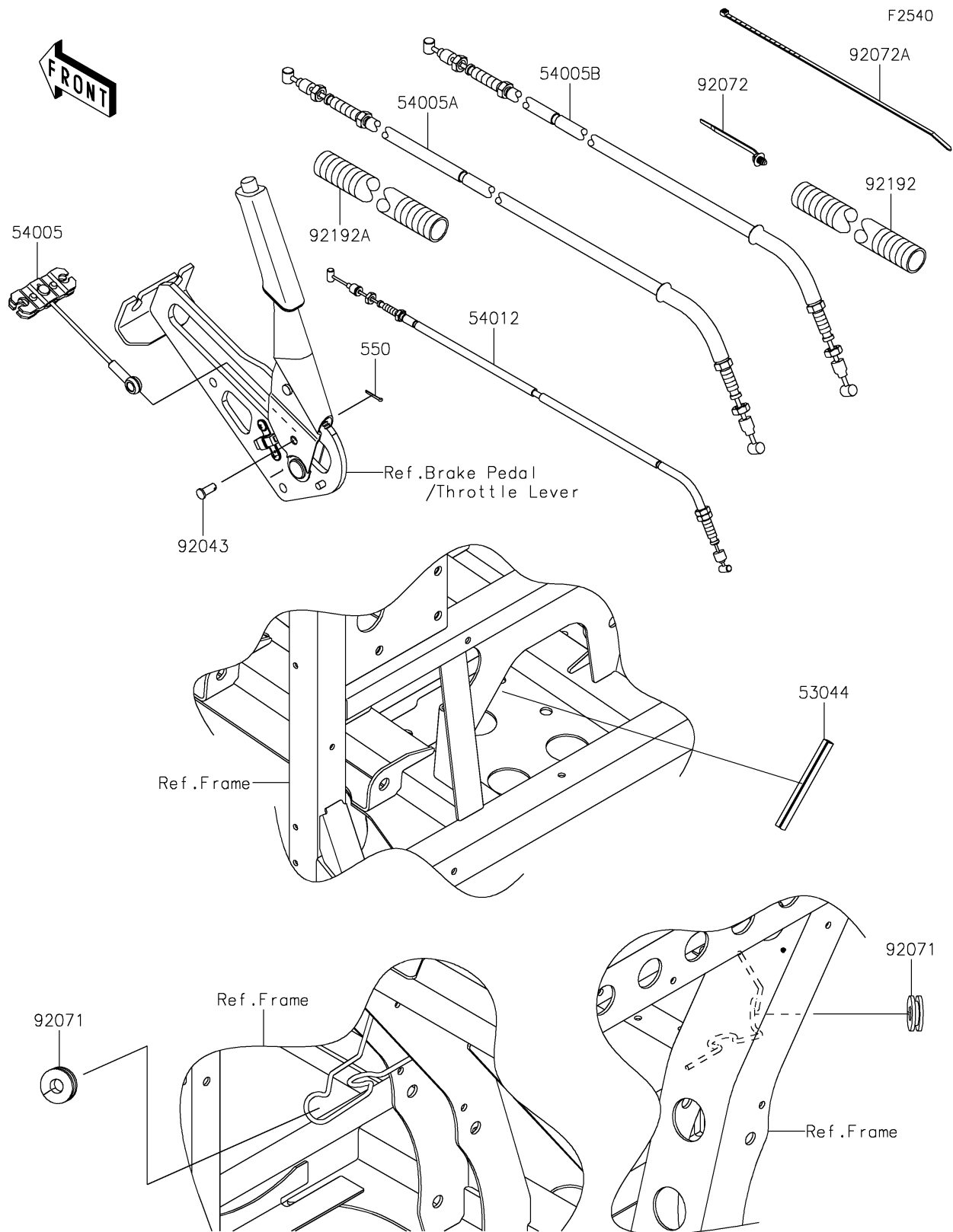

# 2022 MULE PRO-FX™ EPS LE

## PARTS LIST

### Cables

**ITEM NAME**

**PART NUMBER**

**QUANTITY**

---