

# 2021 MULE PRO-FX™ EPS LE

## PARTS DIAGRAM

### Crankcase

E1411

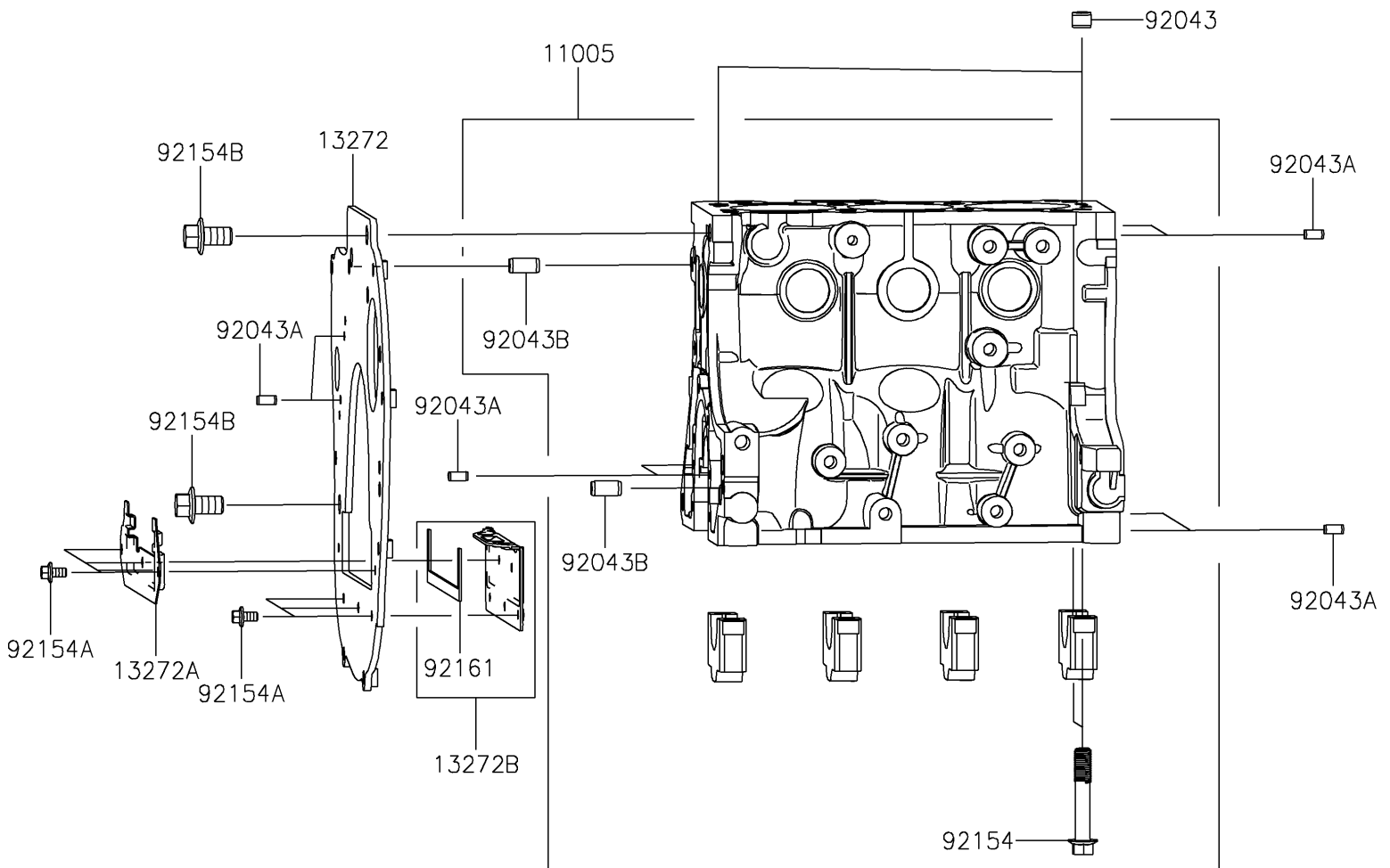

# 2021 MULE PRO-FX™ EPS LE

## PARTS LIST

### Crankcase

**ITEM NAME**

**PART NUMBER**

**QUANTITY**

---