

2022 Concours® 14 ABS

PARTS DIAGRAM

Owner's Tools

56007

F2810

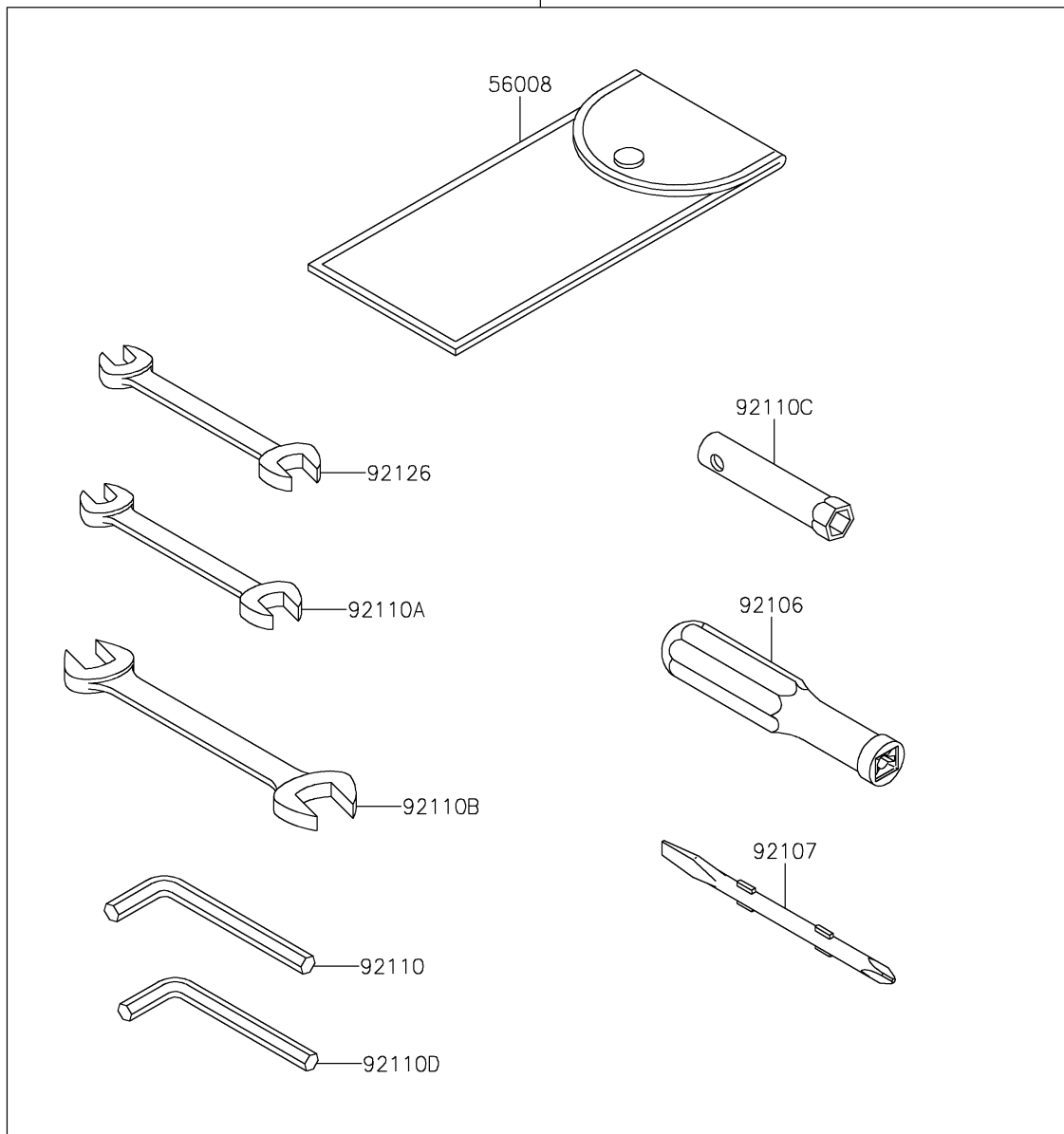

2022 Concours® 14 ABS

PARTS LIST Owner's Tools



ITEM NAME

PART NUMBER

QUANTITY
