

# 2021 CONCOURS® 14 ABS

## PARTS DIAGRAM

### Reflectors

F2790

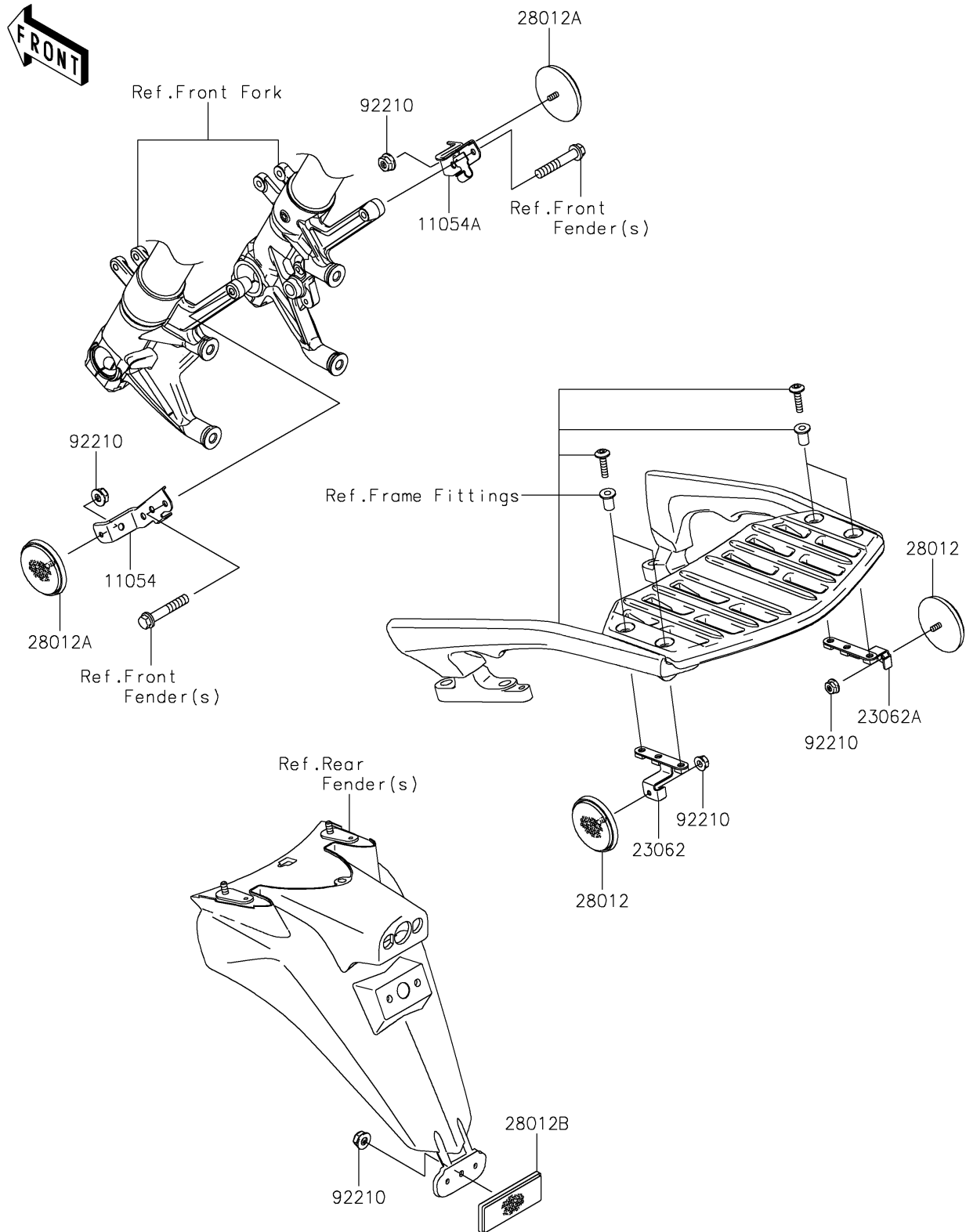

# 2021 CONCOURS® 14 ABS

## PARTS LIST

### Reflectors

**ITEM NAME**

**PART NUMBER**

**QUANTITY**

---