

1999 Vulcan 1500 Nomad

PARTS DIAGRAM

Brake Pedal/Torque Link

F2260

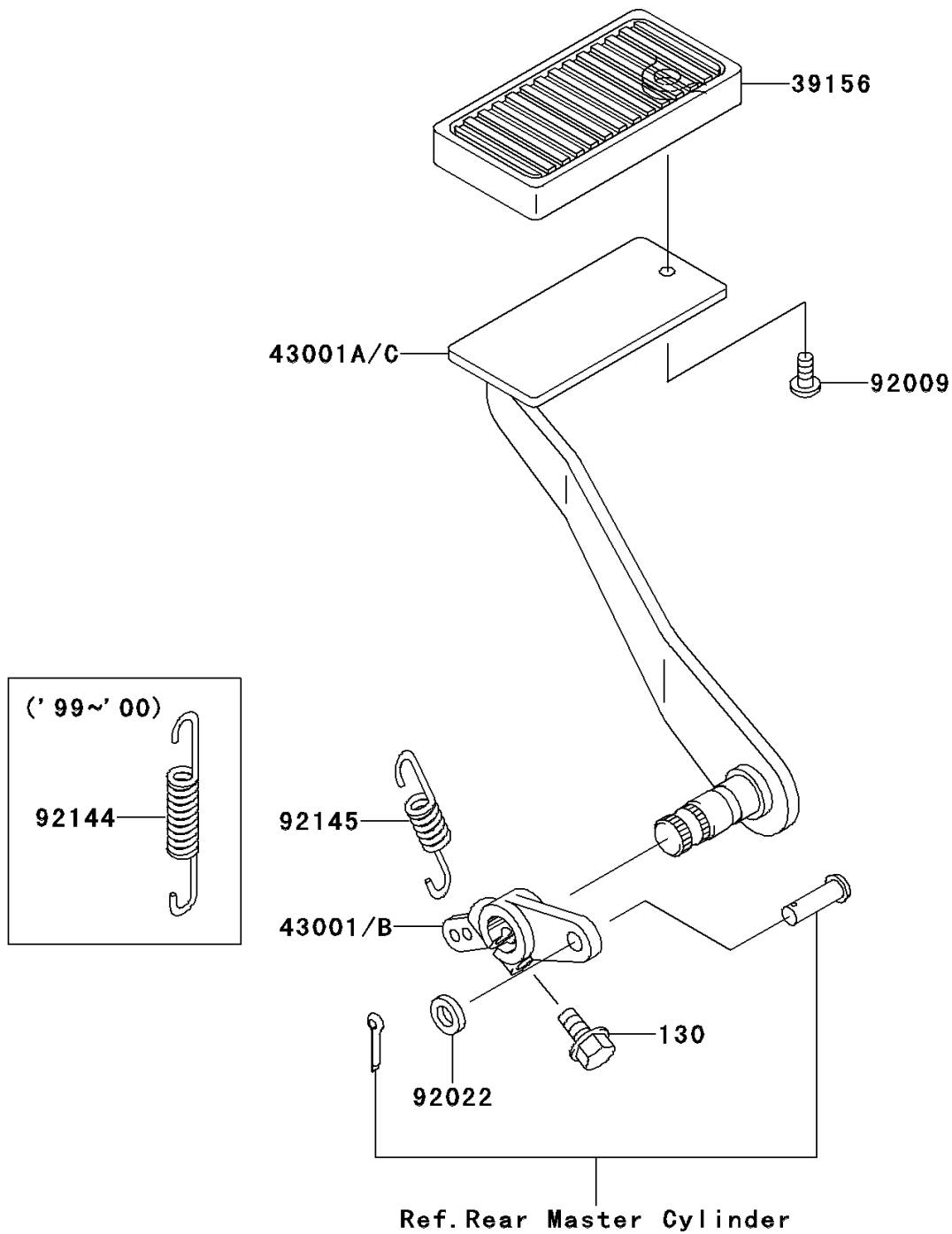

1999 Vulcan 1500 Nomad

PARTS LIST

Brake Pedal/Torque Link

ITEM NAME	PART NUMBER	QUANTITY
-----------	-------------	----------
