

# 1997 Vulcan 1500 Classic

## PARTS DIAGRAM

### Labels

F2860

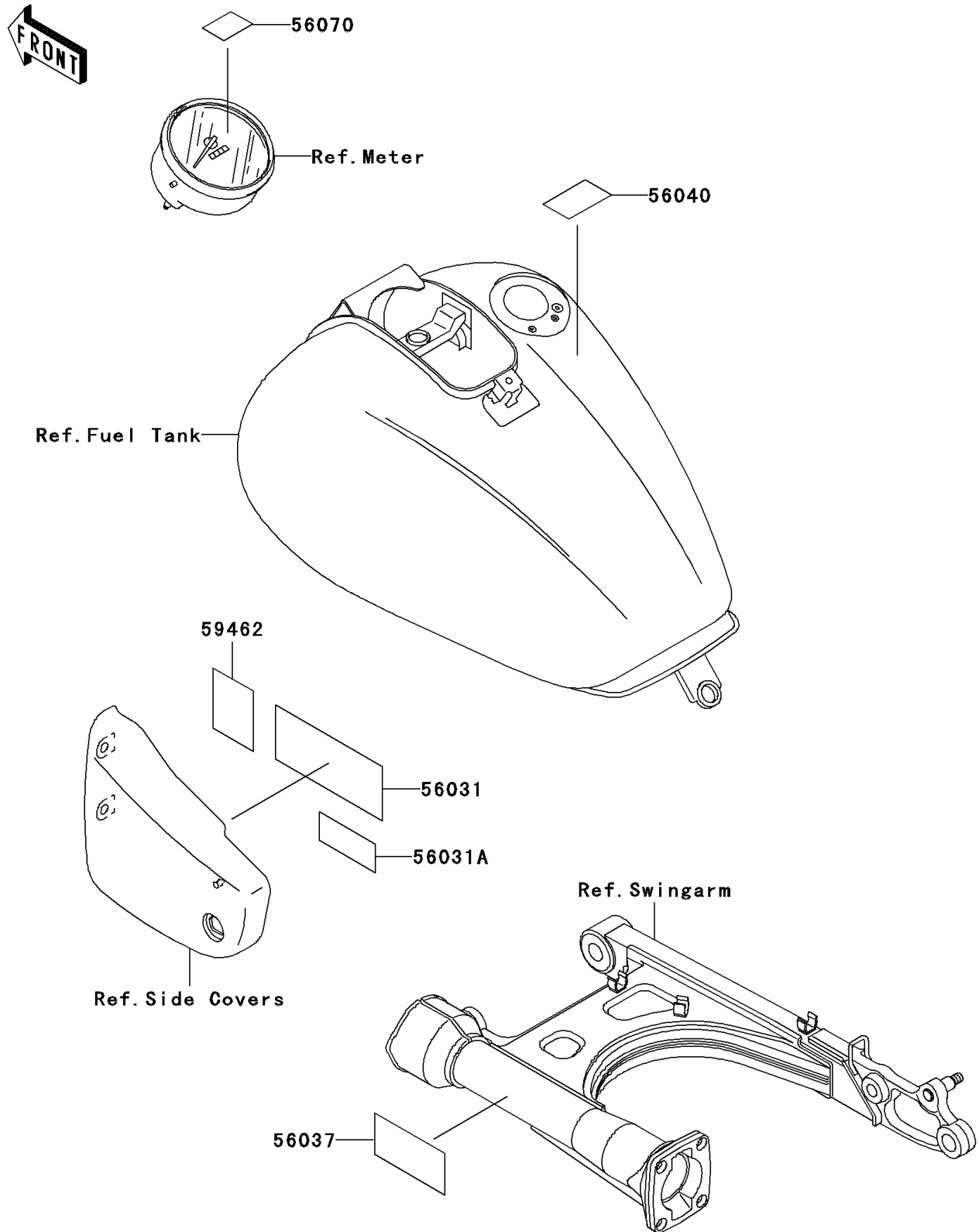

# 1997 Vulcan 1500 Classic

## PARTS LIST

### Labels

**ITEM NAME**

**PART NUMBER**

**QUANTITY**

---