

# 1997 Vulcan 1500 Classic

## PARTS DIAGRAM

### Swingarm

F2141

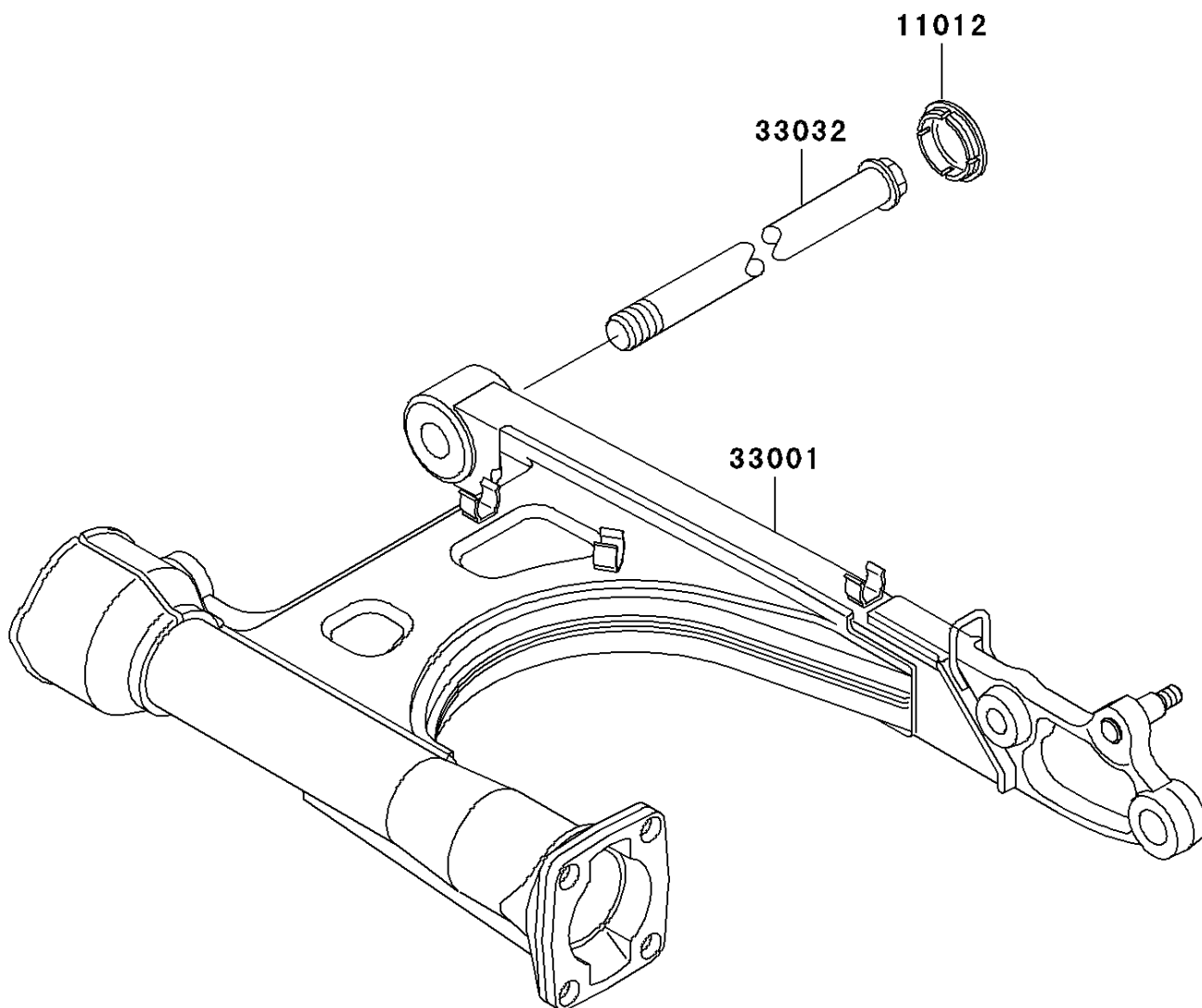

# 1997 Vulcan 1500 Classic

## PARTS LIST

### Swingarm

**ITEM NAME**

**PART NUMBER**

**QUANTITY**

---