

# 2021 MULE SX™

## PARTS DIAGRAM

### Cooling

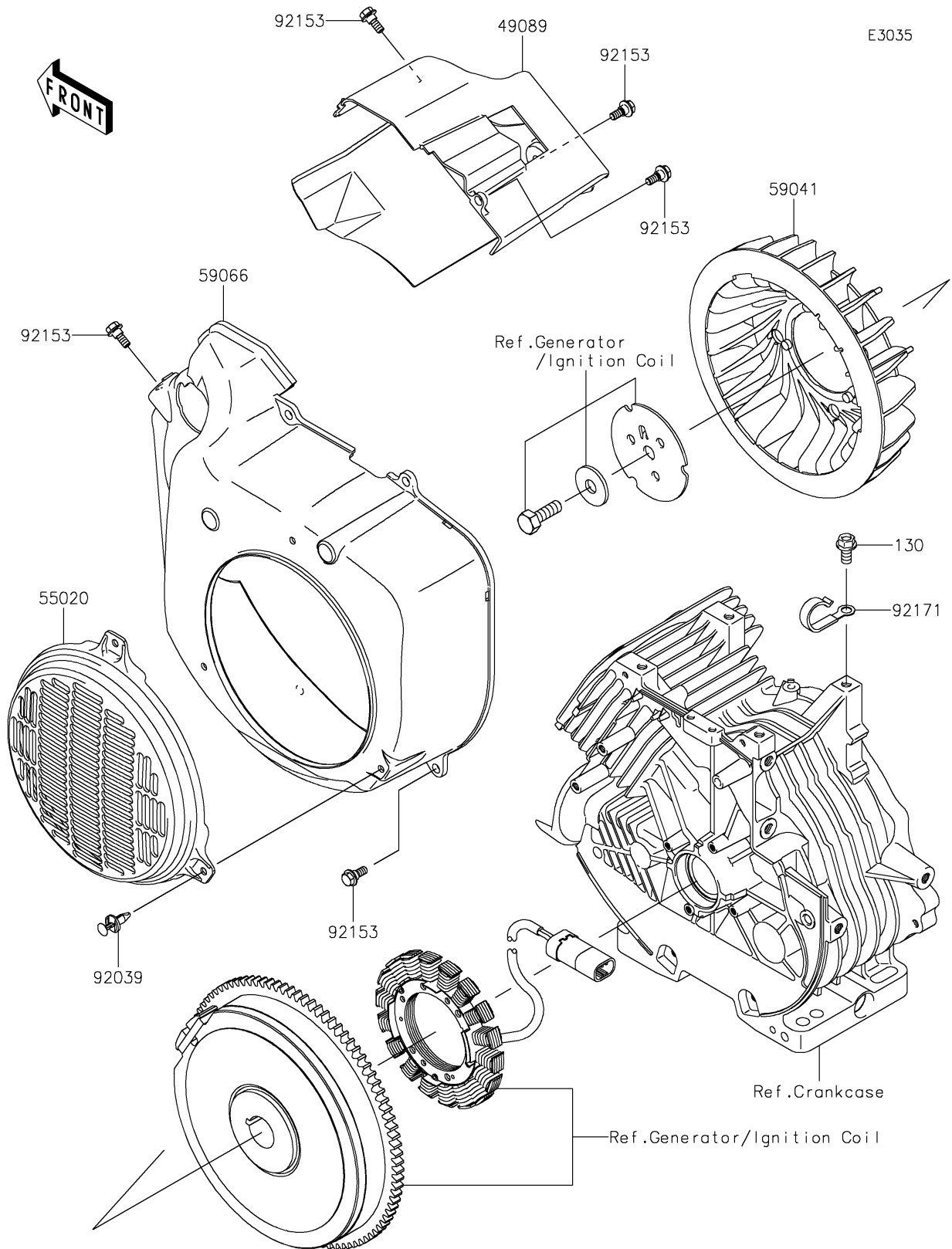

# 2021 MULE SX™

## PARTS LIST

### Cooling

**ITEM NAME**

**PART NUMBER**

**QUANTITY**

---