

1994 Vulcan 88

PARTS DIAGRAM

Taillight(s)

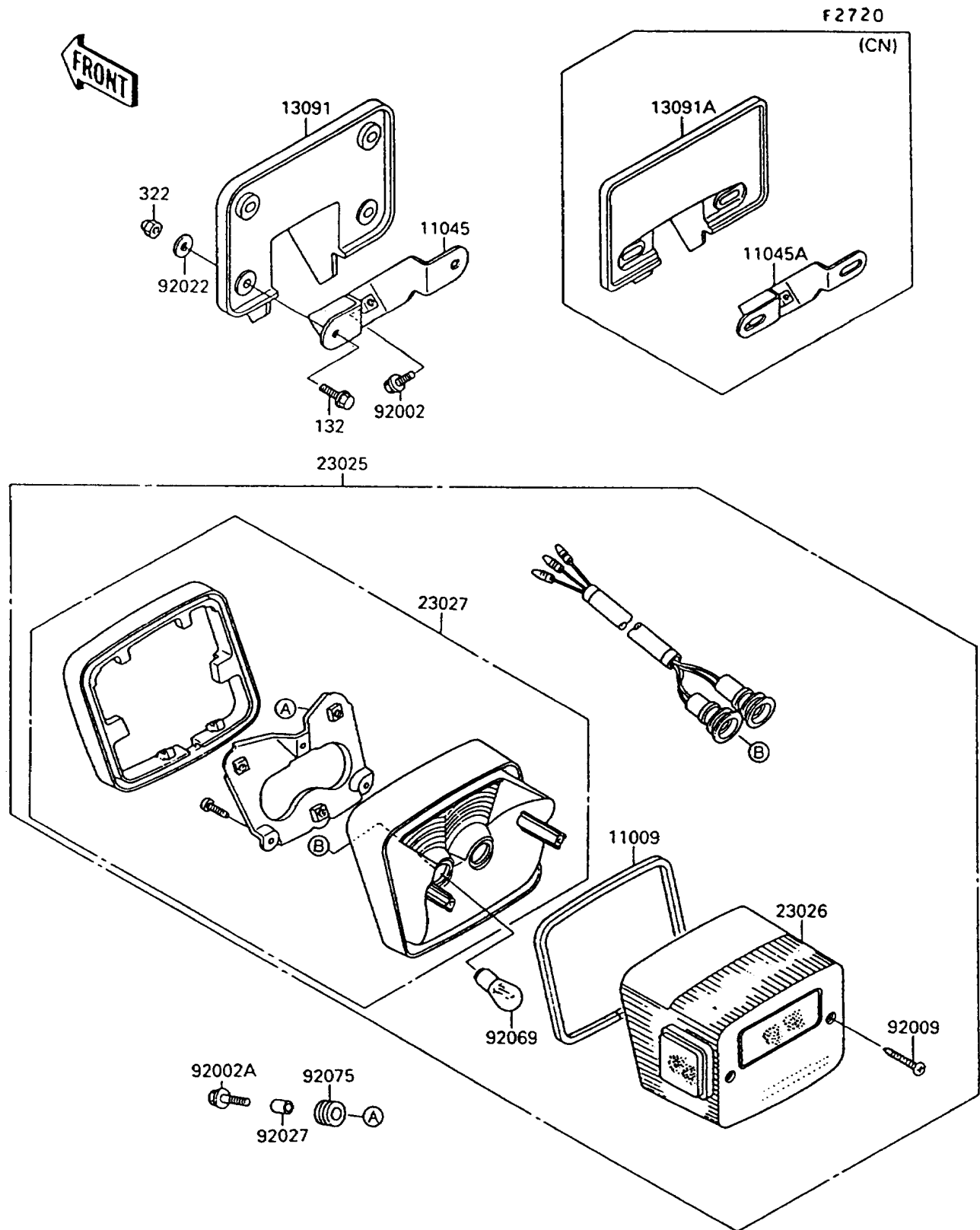

1994 Vulcan 88

PARTS LIST

Taillight(s)

ITEM NAME

PART NUMBER

QUANTITY
