

# 2016 Ninja® 650 ABS

## PARTS DIAGRAM

### Owner's Tools

F2810

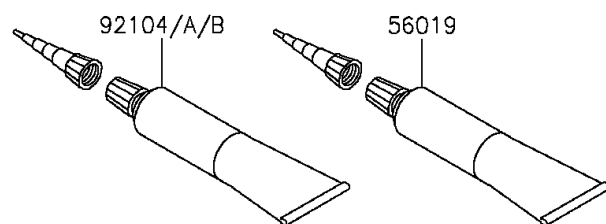
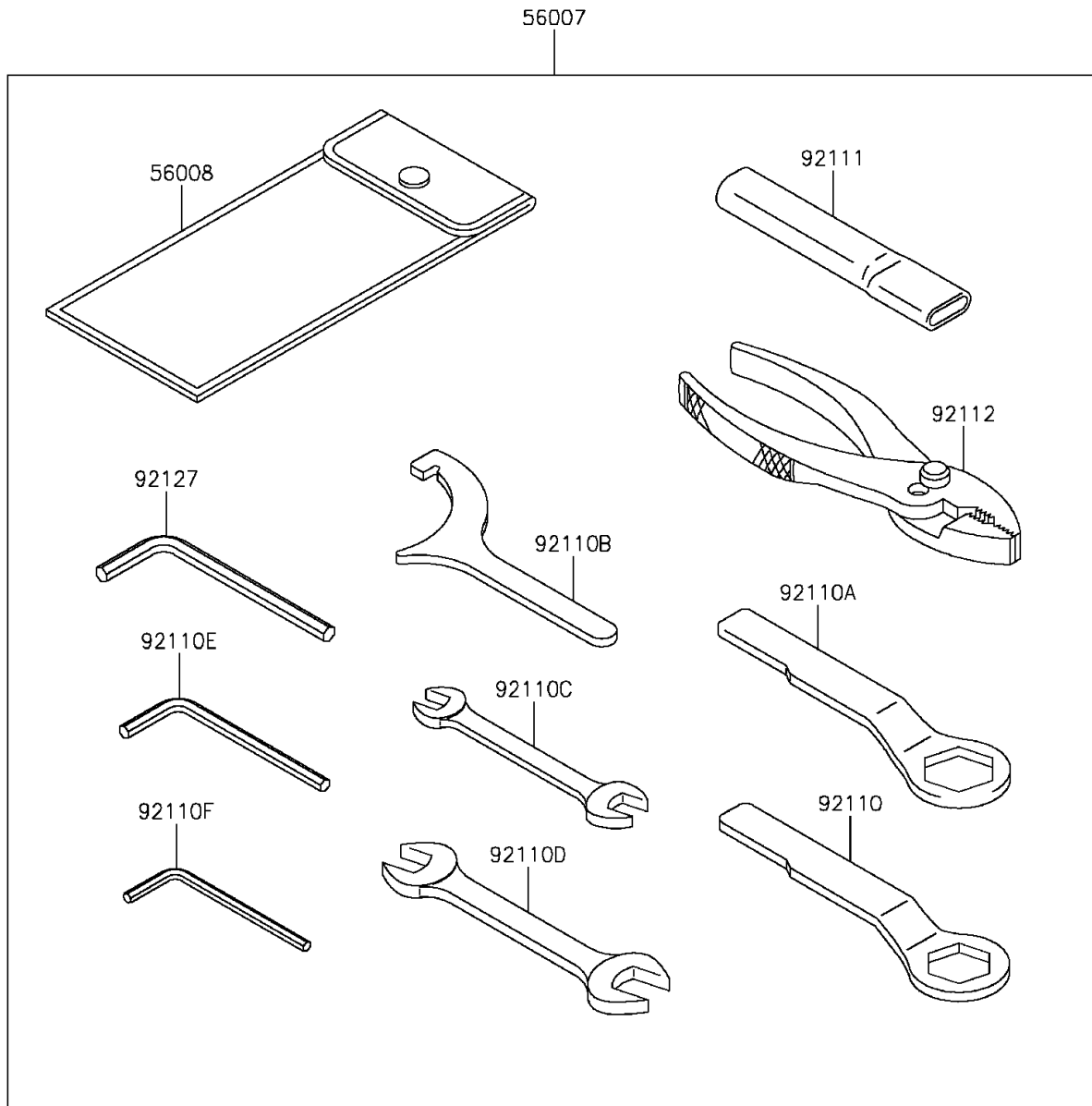

# 2016 Ninja<sup>®</sup> 650 ABS

## PARTS LIST

### Owner's Tools

**ITEM NAME**

**PART NUMBER**

**QUANTITY**

---